

# JVC

ENGLISH  
DEUTSCH  
FRANÇAIS  
NEDERLANDS  
CASTELLANO  
ITALIANO  
PORTUGUÊS

AV28CT1EP

*Natural Vision*  
**T-V LINK**

## AV28CT1EP

### COLOUR TELEVISION

INSTRUCTIONS

FARBFERNSEHGERÄT  
TELEVISEUR COULEUR  
KLEURENTELEVISIE  
TELEVISOR A COLOR  
TELEVISORE A COLORI  
TELEVISOR A CORES

BEDIENUNGSANLEITUNG  
MANUEL D'INSTRUCTIONS  
GEBRUIKSAANWIJZING  
MANUAL DE INSTRUCCIONES  
ISTRUZIONI  
INSTRUÇÕES

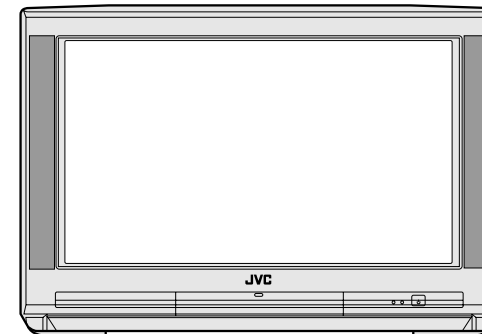

**JVC**  
VICTOR COMPANY OF JAPAN, LIMITED

JVC

Thank you for buying this JVC colour television.

To make sure you understand how to use your new TV, please read this manual thoroughly before you begin.

## **WARNING:**

**TO PREVENT FIRE OR SHOCK HAZARD, DO NOT EXPOSE THIS APPLIANCE TO RAIN OR MOISTURE.**

## **CAUTION:**

**TO ENSURE PERSONAL SAFETY, OBSERVE THE FOLLOWING RULES REGARDING THE USE OF THIS UNIT.**

1. Operate only from the power source specified (AC 220 – 240 V, 50 Hz) on the unit.
2. Avoid damaging the AC plug and power cord.
3. Avoid improper installation and never position the unit where good ventilation is unattainable. When installing this television, distance recommendations must be maintained between the floor and wall, as well as instalment in a tightly enclosed area or piece of furniture. Adhere to the minimum distance guidelines shown for safe operation.
4. Do not allow objects or liquid into the cabinet openings.
5. In the event of a fault, unplug the unit and call a service technician. Do not attempt to repair it yourself or remove the rear cover.
6. The surface of the TV screen is easily damaged. Be very careful with it when handling the TV. Should the TV screen become soiled, wipe it with a soft dry cloth. Never rub it forcefully. Never use any cleaner or detergent on it.

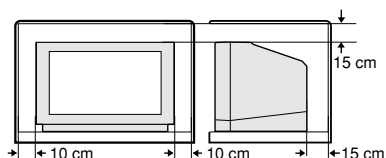

When you do not use this TV set for a long period of time, be sure to disconnect the power plug from the AC socket.

## **CONTENTS**

PREPARATION . . . . .	2
T-V LINK FUNCTIONS . . . . .	5
BASIC OPERATION . . . . .	6
REMOTE CONTROL BUTTONS AND FUNCTIONS . . . . .	9
MENU OPERATION . . . . .	14
PICTURE SETTING. . . . .	15
PICTURE FEATURES. . . . .	16
SOUND SETTING . . . . .	18
EXT SETTING . . . . .	19
FEATURES . . . . .	21
INSTALL . . . . .	23
DEMO . . . . .	27
ADDITIONAL MENU OPERATIONS . . . . .	28
ADDITIONAL PREPARATION. . . . .	30
CH/CC NUMBER. . . . .	32
TV BUTTONS AND PARTS. . . . .	33
TROUBLESHOOTING. . . . .	34
SPECIFICATIONS. . . . .	36

# PREPARATION

## ■ Connecting the Aerial and VCR

If connecting a VCR, follow (A) → (B) → (C) → (D).  
If not connecting a VCR, follow ① → ②.

\*1: To operate T-V LINK functions, a T-V LINK compatible VCR must be connected to the EXT-2 terminal on the TV. For details about T-V LINK functions, see "T-V LINK FUNCTIONS" on page 5.

### Note:

- For further details, refer to the manuals provided with the devices to be connected.
- The connecting cables are not provided.
- A video can be viewed from the VCR without performing (C). For details, refer to your VCR instruction manual.
- To connect additional external devices, please see "ADDITIONAL PREPARATION" on page 30.
- When a decoder is connected to a T-V LINK compatible VCR, set the DECODER (EXT-2) function to ON. For details, see "Using the DECODER (EXT-2) function" on page 28. Otherwise, you will not be able to view scrambled channels.

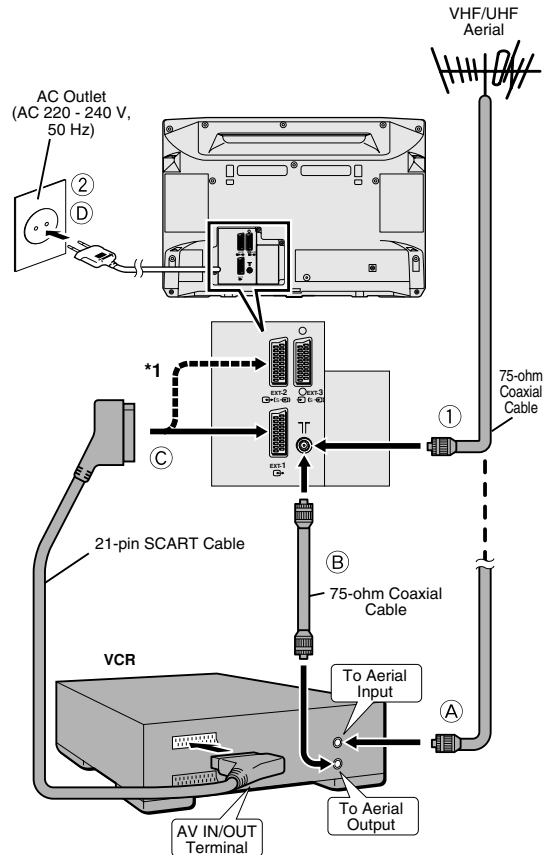

## ■ Putting Batteries into the Remote Control

Use two AAA/R03 dry cell batteries.

Insert the batteries from the ⊖ end, making sure the ⊕ and ⊖ polarities are correct.

To open the battery compartment, slide the door downwards and lift off. Replace the door by sliding it upwards until it is secure.

### Note:

- Follow the warnings printed on the batteries.
- Battery life is about six months to one year, depending on your frequency of use.
- If the remote control does not work properly, replace the batteries.
- The batteries we supply are only for setting up and testing your TV, please replace them as soon as necessary.
- Always use good quality batteries.

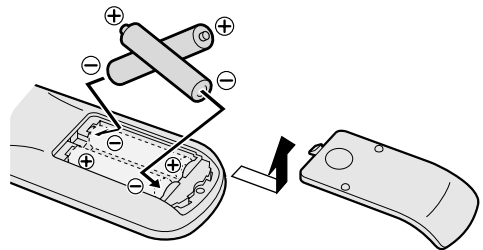

## ■ Initial Settings

When the TV is first turned on, it enters the initial setting mode, and the JVC logo is displayed. Follow the instructions on the on-screen display to make the initial settings.

### 1 Press the Main power button on the TV.

The Power lamp lights red (for power on), then green (for TV on) and the JVC logo is displayed.



**Note:**

- If the power lamp stays red and does not change to green:  
Your TV is in the standby mode. Press the (Standby) button on the remote control to turn your TV on.
- The JVC logo does not appear when your TV has been turned on once.  
In this case, use the "LANGUAGE" and "AUTO PROGRAM" functions to make the initial settings. For details, see "INSTALL" on page 23.

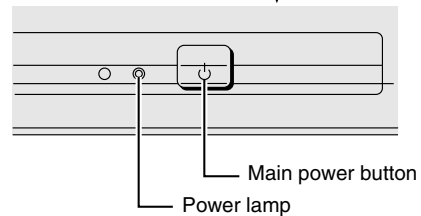
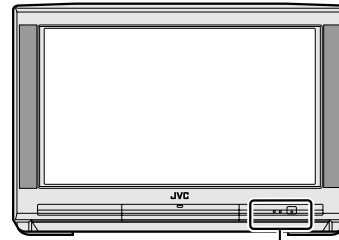

### 2 Press the OK button.

The LANGUAGE menu appears.



### 3 Press the / buttons to choose ENGLISH. Then press the OK button.

English is set for the on-screen display description. The COUNTRY menu appears as a sub-menu of the AUTO PROGRAM function.

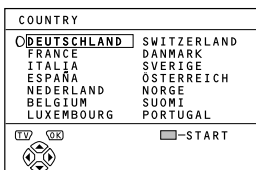

### 4 Press the / and / buttons to choose the country where you are now located.

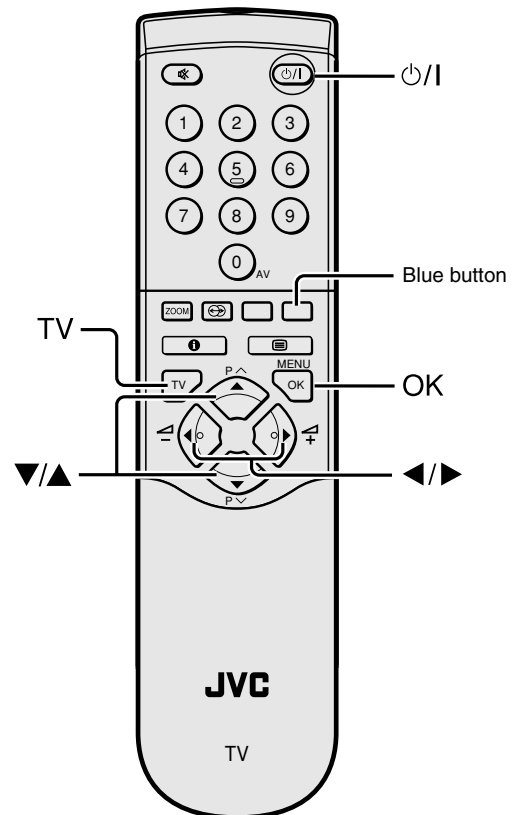

**5 Press the blue button to start the AUTO PROGRAM function.**

The AUTO PROGRAM menu appears and received TV channels are automatically registered in the Programme numbers (PR).

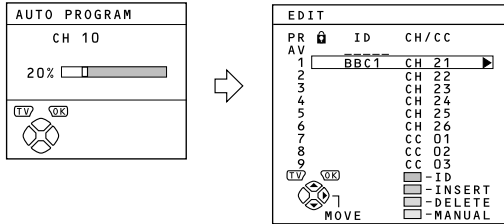

**To cancel the AUTO PROGRAM function:**

Press the TV button.

**6 After the TV channels have been registered in the Programme numbers (PR), the EDIT menu appears.**

You can proceed to edit the Programme numbers (PR) using the EDIT/MANUAL function. For details, see "EDIT/MANUAL" on page 24.

**When not using the EDIT/MANUAL function:**

If you do not need to use the EDIT/MANUAL function, go to the next step.

**7 Press the OK button to display the T-V LINK menu.**

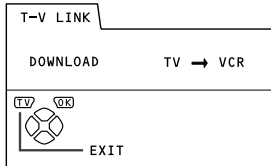

**8 Operate the T-V LINK menu according to the type of a VCR connected to the EXT-2 terminal.**

**When a T-V LINK compatible VCR is not connected:**

Press the TV button to exit the T-V LINK menu. The T-V LINK menu disappears.

**When a T-V LINK compatible VCR is connected:**

Follow the operating procedure "Downloading the data to VCR" on page 28 to transmit the Programme number (PR) data.

**9 Now, the initial settings are complete, and you can watch the TV.**

**Note:**

- When your TV can detect the TV channel name from the TV channel broadcast signal, it automatically registers the TV channel name (ID) to the Programme number (PR) in which the TV channel has been registered.
- If a TV channel you want to view is not set to a Programme number (PR), manually set it using the MANUAL function. For details, see "EDIT/MANUAL" on page 24.
- The TV channel is not registered in Programme number PR 0 (AV). When you want to register a TV channel to PR 0 (AV), manually set it using the MANUAL function. For details, see "EDIT/MANUAL" on page 24.

# T-V LINK FUNCTIONS

When a T-V LINK compatible VCR is connected to the EXT-2 Terminal on the TV, it is easier to set up the VCR and to view videos. T-V LINK uses the following features:

## To use T-V LINK functions:

A T-V LINK compatible VCR is necessary.

The VCR must be connected to the EXT-2 terminal on the TV by a fully wired SCART cable.

## Note:

- A "T-V LINK compatible VCR" means a JVC VCR with the T-V LINK logo or a VCR with one of the following logos. However, these VCRs may support some or all of the features described below. For details, refer to your VCR instruction manual.

"Q-LINK" (a trademark of Panasonic Corporation)

"Data Logic" (a trademark of Metz Corporation)

"Easy Link" (a trademark of Phillips Corporation)

"Megalogic" (a trademark of Grundig Corporation)

"SMARTLINK" (a trademark of Sony Corporation)

## ■ Pre-set Download

Download the registered data on the TV channels from the TV to the VCR.

The Preset Download function automatically begins when the initial setting is complete or whenever the AUTO PROGRAM or EDIT/MANUAL operations are performed.

## Note:

- This function can be operated via VCR operation.

## When "FEATURE NOT AVAILABLE" is displayed:

If "FEATURE NOT AVAILABLE" is displayed, the download was not performed correctly. Before trying to download again, ensure the following:

- The VCR power is turned on.
- The VCR is T-V LINK compatible.
- The VCR is connected to the EXT-2 terminal.
- The SCART cable is fully wired.

## ■ Direct Rec

"What You See Is What You Record"

You can record to VCR the images that you are currently viewing on TV by a simple operation.

For details, read the manual for your VCR.

Operate via the VCR. "VCR IS RECORDING" is displayed.

**In the following conditions, the VCR will stop recording if the TV is turned off, if the TV channel or input is switched, or if the menu is displayed on the TV:**

- When recording images from an external device connected to the TV.
- When recording a TV channel after it has been unscrambled on a decoder.
- When recording a TV channel by using the TV's output because that TV channel cannot be properly received on the VCR's tuner.

## Note:

- Operation via the TV is not possible.
- Generally, the VCR cannot record a TV channel that cannot be received properly by the VCR's tuner, even though you can view that TV channel on the TV. However, some VCRs can record a TV channel by using the TV's output if that channel can be viewed on the TV, even though the TV channel cannot be received properly by the VCR's tuner. For details, refer to your VCR instruction manual.

## ■ TV Auto Power On/VCR Image View

When the VCR starts playing, the TV automatically turns on and the images from EXT-2 terminal are displayed on the screen.

When the VCR menu is operated, the TV automatically turns on and the images from EXT-2 terminal are displayed on the screen.

## Note:

- This function does not operate if your TV's main power is turned off. Set your TV's main power to on (standby mode).

# BASIC OPERATION

## ■ Turn the Main power on

Press the Main power button on the TV.

The Power lamp lights red and your TV is in the standby mode.

**Note:**

- If the Power lamp lights green, the TV is already on.

**To turn the Main power off:**

Press the Main power button again.  
The Power lamp goes off.

**Note:**

- To save energy, turn the main power off if you are not using the TV for a long period of time.

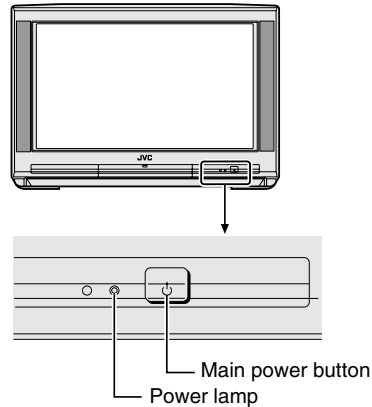

## ■ Turn the TV on from standby mode

Press the (Standby) button, the TV button, the buttons or the Number buttons.

The Power lamp lights red to green and your TV will be turned on.

**To turn the TV off:**

Press the (standby) button again.  
The Power lamp changes from green to red and the TV enters standby mode.

## ■ Choose a TV channel

Choose a Programme number (PR) in which the desired Programme TV channel has been set.

**Use the buttons:**

Press the buttons to choose the desired Programme number (PR).

**Use the Number buttons:**

Enter the desired Programme number (PR) with the Number buttons.

*Example*

- PR12 → press **1** and **2**.
- PR6 → press **6**.

**Use the PR LIST:**

**1** Press the (Information) button to display the PR LIST.

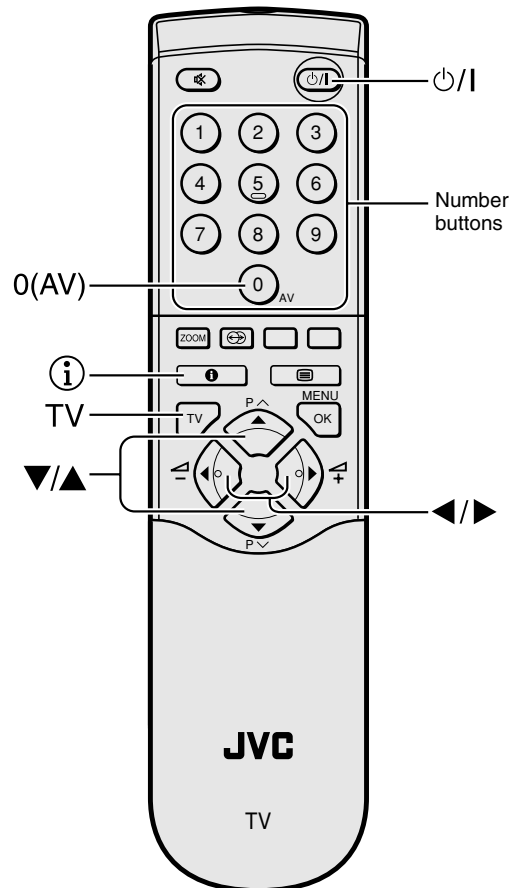

PR LIST	
PR	ID
AV	
1	BBC1
2	
3	
4	
5	
6	
7	
8	
9	

-10 +10



**2 Press the ◀/▶ and ▼/▲ buttons to choose a Programme number (PR). Then press the OK button.**

**Note:**

- For Programme numbers (PR) with the CHILD LOCK function set, the  (CHILD LOCK) mark is displayed next to the Programme number (PR) in the PR LIST.
- You cannot use the ▼/▲ buttons to choose a Programme number (PR) with the CHILD LOCK function set.
- Even if you try to choose a Programme number (PR) with the CHILD LOCK function set, the  (CHILD LOCK) mark will appear, and you cannot watch the TV channel. To watch the TV channel, see "CHILD LOCK" on page 21.
- If you do not have a clear picture or no colour appears, change the colour system manually. See "COLOUR SYSTEM" on page 16.

**■ Adjust the volume**

**Press the ◀/▶ buttons to adjust the volume.**

The Volume indicator appears and the volume changes as you press the -/+ buttons.

**■ Watch images from external devices**

Choose an EXT terminal to which the desired external device has been connected.

**Use the 0 (AV) button:**

Press the 0 (AV) button to choose an EXT terminal.

Pressing the 0 (AV) button changes the choice as follows:

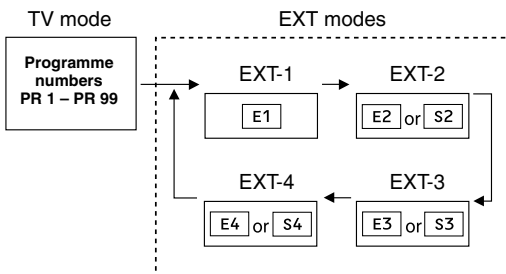

**Use the ▼/▲ buttons:**

Press the ▼/▲ buttons to choose an EXT terminal.

**Use the PR LIST:**

**1 Press the ⓘ (Information) button to display the PR LIST.**

**2 Press the ◀/▶ and ▼/▲ buttons to choose an EXT terminal. Then press the OK button.**

**Note:**

- The EXT terminals are registered after the Programme number PR 99.
- You can choose a video input signal from the S-VIDEO signal (Y/C signal) and regular video signal (composite signal). For details, see "S-VIDEO (S-VIDEO input)" on page 19.
- If you do not have a clear picture or no colour appears, change the colour system manually. See "COLOUR SYSTEM" on page 16.
- When choosing an EXT terminal with no input signal, the EXT terminal number becomes fixed on the screen.
- This TV set has a function which can automatically change over the input according to a special signal output from an external device. (The EXT-4 terminal does not support it.)

**To return to a TV channel:**

Press the TV button, the ▼/▲ buttons or the Number buttons.

**To use the Programme number PR 0 (AV):**

When the TV and VCR are connected only by the Aerial cable, choosing the Programme number PR 0 (AV) allows you to view images from the VCR. Set the VCR RF channel to the Programme number PR 0 (AV) manually. For details, see "EDIT/MANUAL" on page 24.

Pressing the 0 (AV) button changes the choice as follows:

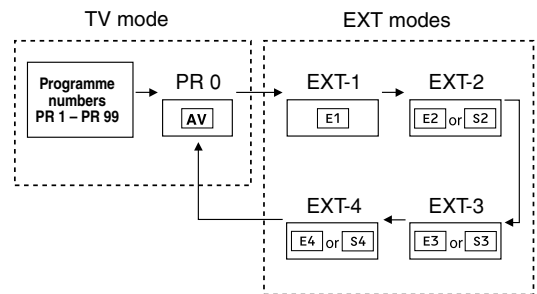

**Note:**

- The VCR RF channel is sent as the RF signal from the VCR.
- Also refer to your VCR instruction manual.



## ■ Operating with the buttons on the TV

- 1** Press the P  $\nabla/\wedge$  buttons to turn the TV on from standby mode.
- 2** Press the P  $\nabla/\wedge$  buttons to choose a Programme number (PR) or an EXT terminal.
- 3** Press the  $\triangleleft$  (Volume) button and the  $-/+$  buttons to adjust the volume.
  - 1** Press the  $\triangleleft$  (Volume) button.  
The volume level indicator appears.
  - 2** Press the  $-/+$  buttons while the volume level indicator is displayed.

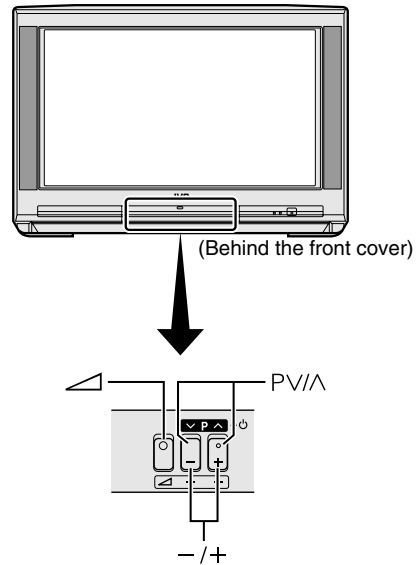

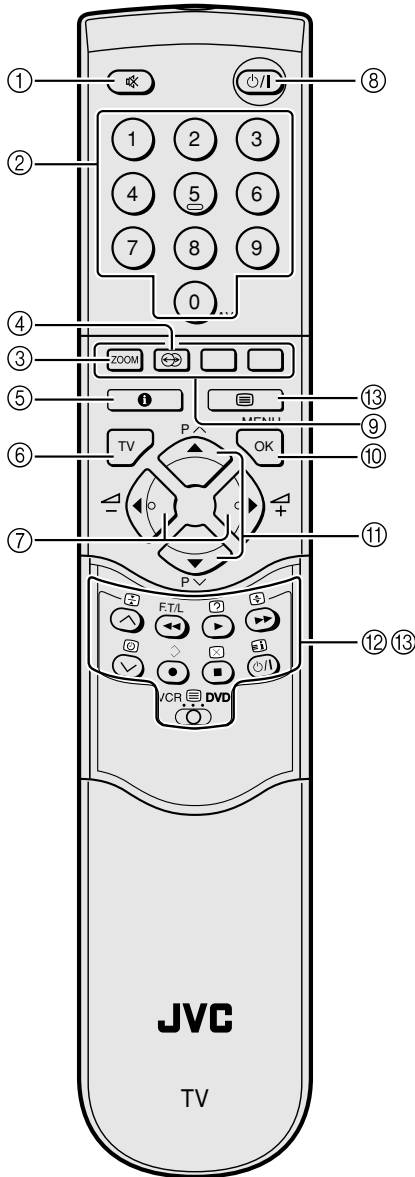

# REMOTE CONTROL BUTTONS AND FUNCTIONS



## ① Muting Button

You can turn the volume off instantly.

Press the  (Muting) button to turn off the Volume. Pressing the  (Muting) button again resumes the previous Volume level.

## ② Number Buttons

You can choose a Programme number (PR) by entering the Programme number.

Example:

- PR12 → press 1 and 2.

- PR6 → press 6.

You can also press the 0 (AV) button repeatedly to choose an EXT terminal.

## ③ ZOOM Button

You can change the screen size according to the picture aspect ratio. Choose the optimum one from the following ZOOM modes.

### AUTO(WSS):

When a WSS (Wide Screen Signalling) signal, which shows the aspect ratio of the picture, is included in the broadcast signal or the signal from an external device, the TV automatically changes the ZOOM mode to 16:9 ZOOM mode or FULL mode according to the WSS signal.

If a WSS signal is not included, the picture is displayed in accordance with the ZOOM mode set with the 4:3 AUTO ASPECT function.

### Note:

- For details of the 4:3 AUTO ASPECT function, see "4:3 AUTO ASPECT" on page 17.
- When the AUTO(WSS) mode does not function correctly due to poor WSS signal quality or when you want to change the ZOOM mode, press the **ZOOM** button and change to another ZOOM mode.

### REGULAR:

Use to view a normal picture (4:3 aspect ratio) as its original size is.



**PANORAMIC:**

This mode stretches the left and right sides of a normal picture (4:3 Aspect Ratio) to fill the screen, without making the picture appear unnatural.

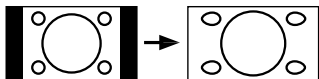

**Note:**

- The top and bottom of the picture are slightly cut off.

**14:9 ZOOM:**

This mode zooms up the Wide Picture (14:9 Aspect Ratio) to the upper and lower limits of the screen.



**16:9 ZOOM:**

This mode zooms up the Wide Picture (16:9 Aspect Ratio) to the full screen.



**16:9 ZOOM SUBTITLE:**

This mode zooms up the Wide Picture (16:9 Aspect Ratio) with subtitles to the full screen.



**FULL:**

This mode uniformly stretches the left and right sides of a normal picture (4:3 aspect ratio) to fill the wide TV screen.

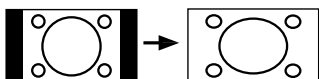

**Note:**

- Use for pictures with a 16:9 aspect ratio that have been squeezed into a normal picture (4:3 aspect ratio), you can restore their original dimensions.

**Choose the ZOOM mode**

- 1 Press the **ZOOM** button to display the ZOOM menu.

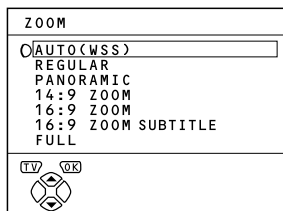

- 2 Press the **▼/▲** buttons to choose a **ZOOM** mode. Then press the **OK** button.

The picture expands and the chosen ZOOM mode is displayed in about 5 seconds.

**Note:**

- The ZOOM mode may be automatically changed due to the control signal from an external device. When you want to return to the previous ZOOM mode, choose the ZOOM mode again.

**Adjusting the visible area of the picture**

If subtitles or the top (or bottom) of the picture are cut off, adjust the visible area of the picture manually.

- 1 Press the **ZOOM** button.

The ZOOM menu appears.

- 2 Press the **OK** button to display the ZOOM mode indication.

Indicator is displayed.

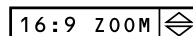

- 3 While it is displayed, press the **▼/▲** buttons to adjust the visible area vertically.

**Note:**

- You cannot adjust the visible area in REGULAR or FULL mode.

**④ HYPER SOUND Button**

You can enjoy sounds with a wider ambience.

Press the **Ⓜ** (HYPER SOUND) button to turn the HYPER SOUND function on or off.

**Note:**

- The HYPER SOUND function does not work properly with mono sound.
- The HYPER SOUND function can be also turned on or off by using the SOUND SETTING menu. For details, see "HYPER SOUND" on page 18.

## ⑤ Information Button

You can display the PR LIST or the Current Time on the screen.

Press the **ⓘ** (Information) button.

Pressing the **ⓘ** (Information) button changes the display as follows:

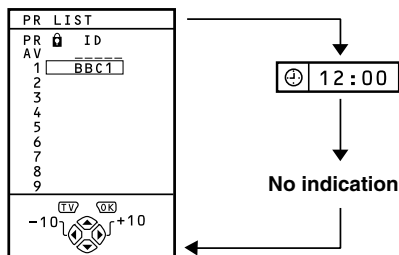

### Note:

- You can choose Programme numbers (PR) or EXT terminals with the PR LIST. For details, see "Use the PR LIST:" on page 6.
- This TV uses teletext data to set the current time. If the TV has not received a TV channel that has teletext programmes since it was turned on, the time display is blank. To view the current time, choose a TV channel that has teletext programmes. The time will still be displayed as long as you do not turn off the TV, even if you choose other TV channels.
- When watching videos, an incorrect current time is sometimes displayed.
- The **ⓘ** (Information) button is also used to operate menus. For details, see "MENU OPERATION" on page 14.

## ⑥ TV Button

You can return to a TV channel instantly.

Press the **TV** button.

The TV returns to the TV mode and a TV channel appears.

### Note:

- The **TV** button is also used to operate menus. For details, see "MENU OPERATION" on page 14.

## ⑦ ◀▶ Buttons

You can adjust the volume.

Press the **◀▶** buttons to adjust the sound.

### Note:

- The **◀▶** buttons are also used to operate menus. For details, see "MENU OPERATION" on page 14.

## ⑧ Standby Button

Press the **⏻/I** (Standby) button to turn the TV on or off.

When the TV is turned on, the power lamp changes from red to green.

## ⑨ Colour Buttons

The colour buttons are used for the teletext operations or the menu operations. For details, see "⑬ Teletext Control Buttons and VCR **⏻** DVD Switch" on page 12 or "MENU OPERATION" on page 14.

## ⑩ OK Button

The **OK** button is used to operate menus. For details, see "MENU OPERATION" on page 14.

## ⑪ ▼/▲ Buttons

You can choose a Programme number (PR) or an EXT terminal.

Press the **▼/▲** buttons to choose an Programme number (PR) or an EXT terminal.

The **▼/▲** buttons are also used to operate menus. For details, see "MENU OPERATION" on page 14.

## ⑫ VCR/DVD Control Buttons and VCR **⏻** DVD Switch

These buttons can be used to operate a JVC brand VCR or DVD player. Pressing the button having the same appearance as the original remote control button of a device makes the function work in the same way as the original remote control.

### 1 Set the VCR **⏻** DVD Switch to the VCR or DVD position.

#### VCR:

When you are operating the VCR, set the switch to the VCR position.

#### DVD:

When you are operating the DVD player, set the switch to the DVD position.

#### **⏻** (Text):

When you are viewing Teletext programmes, set the switch to the **⏻** (Text) position.

### 2 Press the VCR/DVD Control Button to control your VCR or DVD player.

#### Note:

- If your device is not made by JVC, these buttons cannot be used.
- Even if your device is made by JVC, some of these buttons or any one of the buttons may not work, depending on the device.
- You can use the **▼/▲** buttons to choose a TV channel. The VCR will receive or choose the chapter the DVD player plays back.
- Some DVD player models use the **▼/▲** buttons for both operating of Fast forward/backward functions and choosing the chapter. In this case, the **◀▶** buttons do not work.

## 13 Teletext Control Buttons and VCR DVD Switch

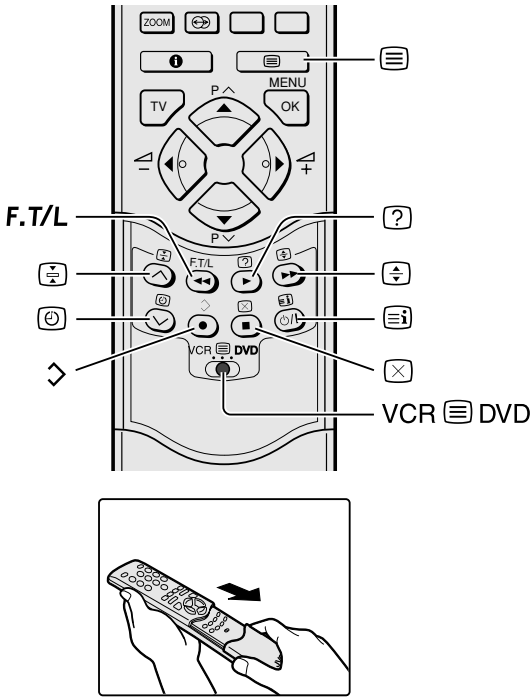

**Note:**

- If you have trouble receiving teletext broadcasts, consult your local dealer or the teletext station,
- In the Text mode, the ZOOM mode is fixed to the FULL mode.
- No menu operations are possible when viewing a teletext programme.

### Using the List Mode

You can store the numbers of your favourite teletext pages in memory and call them up quickly using the colour buttons.

**To store the page numbers:**

**1 Press F.T/L button to engage the List mode.**

The stored page numbers are displayed at the bottom of the screen.

**2 Press a Colour button to choose a position. Then press the Number buttons to enter the page number.**

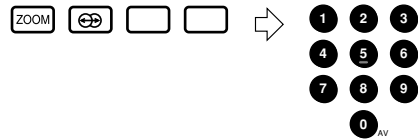

**3 Press and hold down (Store) button.**

The four page numbers blink white to indicate that they are stored in memory.

**To call up a stored page:**

**1 Press the F.T/L button to engage the List mode.**

**2 Press a colour button to which a page has been assigned.**



**To exit the List mode:**

Press the F.T/L button again.

### Basic operation

You can view three types of teletext broadcasts on the TV: FLOF (Fastext), TOP and WST.

- 1 Choose a TV channel with a teletext broadcast.
- 2 Set the VCR DVD switch to the (Text) position.



**3 Press (Text) button to display the teletext.**

Pressing (Text) button changes the mode as follows:

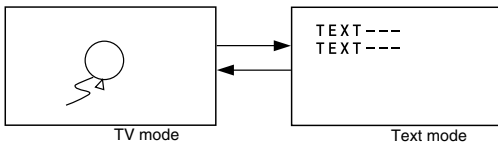

**4 Choose a teletext page by pressing the ▼/▲ buttons, Number buttons or Colour buttons.**

**To return to the TV mode:**

Press the TV button or (Text) button.

### Hold

You can hold a teletext page on the screen for as long as you want, even while several other teletext pages are being received.

**Press the (Hold) button.**

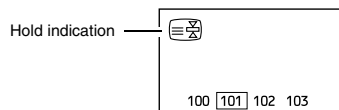

**To cancel the Hold function:**

Press (Hold) button again.

## Sub-page

Some teletext pages include sub-pages that are automatically displayed.

You can hold any sub-page, or view it at any time.

- 1 Press the **[Sub-page]** button to operate the Sub-page function.
- 2 Press the Number buttons to enter a sub-page number.

*Example:*

- 3rd sub-page → press 0, 0, 0 and 3.

**To cancel the Sub-page function:**

Press the **[Sub-page]** (Sub-page) button again.

**Note:**

- You can also choose a sub-page by pressing the red or green button.

## Reveal

Some teletext pages include hidden text (such as answers to a quiz).

You can display the hidden text.

Each time you press the **[Reveal]** button, text is hidden or revealed.

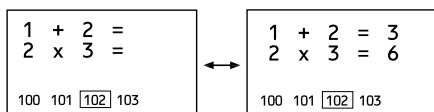

## Size

You can double the height of the teletext display.

Press the **[Size]** button.

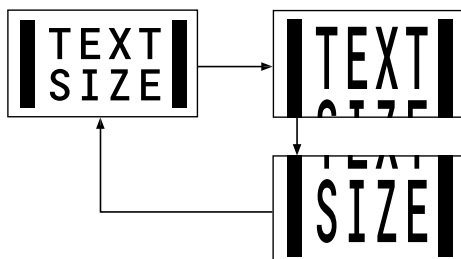

## Index

You can return to the index page instantly.

Press the **[Index]** button.

**FLOF (Fasttext)/TOP/WST:**

Returns to page 100 or a previously specified page.

**List mode:**

Returns to the page number displayed in the lower left area of the screen.

## Cancel

You can search for a teletext page while watching TV.

- 1 Press the Number button to enter a page number, or press a Colour button.

The TV searches for a teletext page.

- 2 Press **[Cancel]** button.

The TV programme appears. When the TV finds the teletext page, its page number appears in the upper left of the screen.

- 3 Press **[Cancel]** button to return to a teletext page when the page number is on the screen.

**Note:**

- The TV mode cannot be resumed even by pressing the **[Cancel]** button. A TV programme is temporarily displayed instead of the teletext programme.

# MENU OPERATION

---

This TV has a number of functions you can operate using menus. To fully utilize all your TV's functions, you need to understand the basic menu operating techniques fully.

## 1 Press the **OK** button to display the **MENU (main menu)**.

The **MENU (main menu)** appears. In it, the titles of the menus are displayed.

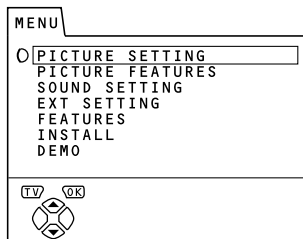

## 2 Press the **▼/▲** buttons to choose a menu title, and press the **OK** button.

The menu appears.

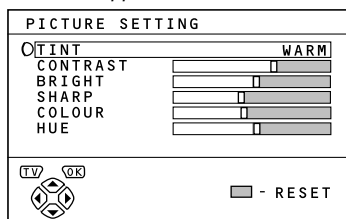

## 3 Operate the menus according to the operation description of each function.

### Note:

- For details, refer to the operation descriptions of each function described for each menu which follows this "MENU OPERATION".
- The display appearing at the bottom of a menu indicates a button on the remote controller you can use when you operate a chosen function.

## 4 Press **OK** button to complete the setting.

The menu disappears.

### To return to the previous menu:

Press **ⓘ** (information) button.

### To exit a menu instantly:

Press the **TV** button.

# PICTURE SETTING

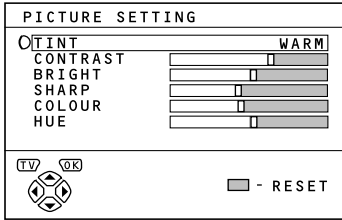

To display the **PICTURE SETTING** menu:

- 1 Press the **OK** button to display **MENU** (main menu).
- 2 Press the **▼/▲** button to choose **PICTURE SETTING**, and press the **OK** button.

## ■ TINT

You can select one of three TINT modes (three kinds of picture settings) to adjust the picture settings automatically.

- 1 Press the **▼/▲** buttons to choose TINT.
- 2 Press **◀/▶** buttons to choose a mode.

### **COOL:**

A cool white colour base with a boost in the colour and contrast levels that creates a more vivid picture.

### **WARM:**

A warm orange/red colour base that creates the appropriate colour and contrast levels for watching films.

### **NORMAL:**

A normal white colour base with normal colour and contrast levels.

- 3 Press the **OK** button to complete the setting.

The menu disappears.

## ■ Picture Adjustment

You can change the picture settings of each TINT mode as you like.

The picture settings changed are stored in the TINT mode.

- 1 Press the **▼/▲** buttons to choose an item.
- 2 Press the **◀/▶** buttons to change the setting.

◀	Item	▶
Lower	<b>CONTRAST</b> (picture contrast)	Higher
Darker	<b>BRIGHT</b> (picture brightness)	Brighter
Softer	<b>SHARP</b> (picture sharpness)	Sharper
Lighter	<b>COLOUR</b> (picture colour)	Deeper
Reddish	<b>HUE</b> (picture hue)	Greenish

### **Note:**

- You can change the HUE setting (picture hue) only when the colour system is NTSC 3.58 or NTSC 4.43.

### **To return to the default settings in each TINT mode:**

Press the blue button.

Returns the picture settings in the currently chosen TINT mode to the default settings, and stores them in the TINT mode again.

- 3 Press the **OK** button to complete the settings.

The menu disappears.



# PICTURE FEATURES

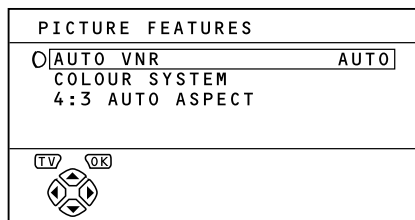

To display the **PICTURE FEATURES** menu:

- 1 Press the **OK** button to display **MENU** (main menu).
- 2 Press the **▼/▲** button to choose **PICTURE FEATURES**, and press the **OK** button.

## ■ AUTO VNR

The **AUTO VNR** function optimally reduces noise of the TV automatically according to the noise of the current picture. The function also adjusts the optimum Sharpness (**SHARP**).

- 1 Press the **▼/▲** buttons to choose **AUTO VNR**.
- 2 Press the **◀/▶** buttons to choose **AUTO**.

### **MIN:**

The **AUTO VNR** function is cancelled. When you set the mode to **AUTO** but feel that the sharpness of the original picture has not been reproduced fully, change the mode to **MIN**. However, a noise remaining in the original picture may be emphasized.

### **MAX:**

This mode always maximizes the noise reduction effect irrespective of state of the picture. When you set the mode to **AUTO** but feel that the noise is remarkable, change the mode to **MAX**. However, this may reduce the sharpness of the picture.

- 3 Press the **OK** button to complete the setting.

The menu disappears.

## ■ COLOUR SYSTEM

The colour system is chosen automatically. However, if the picture is not clear or no colour appears, choose the colour system manually.

- 1 Press the **▼/▲** buttons to choose **COLOUR SYSTEM**. Then press the **OK** button.

The Sub-menu of the **COLOUR SYSTEM** function appears.

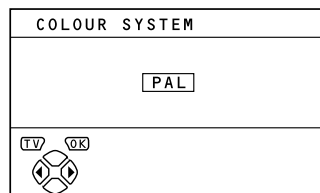

- 2 Press the **◀/▶** buttons to choose the appropriate colour system.

### **PAL:**

PAL system

### **SECAM:**

SECAM system

### **NTSC 3.58:**

NTSC 3.58 MHz system

### **NTSC 4.43**

NTSC 4.43 MHz system

### **AUTO:**

This function detects a colour system from the input signal. Only when you are viewing a picture from Programme number **PR 0** (AV), or **EXT** terminal, you can choose using the **AUTO** function.

- 3 Press the **OK** button to complete the setting.

The menu disappears.

### **Note:**

- The **AUTO** function may not function properly if you have poor signal quality. If the picture is abnormal in the **AUTO** function, choose another colour system manually.
- When in the Programme numbers **PR 0** (AV) to **PR 99**, you cannot choose **NTSC 3.58** or **NTSC 4.43**.

## ■ 4:3 AUTO ASPECT

This function only works when the ZOOM mode is set to AUTO (WSS) mode. It sets the ZOOM mode you want to use for when a WSS signal is not included in the broadcast signal or the signal from an external device. You can choose one of three ZOOM modes.

**Note:**

- For details of the AUTO(WSS) mode, see the "AUTO(WSS)" section within "③ ZOOM Button" on page 9.

### 1 Press the ▼/▲ buttons to choose 4:3 AUTO ASPECT. Then press the OK button.

The Sub-menu of the 4:3 AUTO ASPECT function appears.

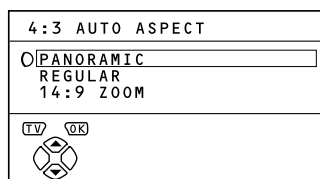

### 2 Press the ▼/▲ buttons to choose a ZOOM mode.

### 3 Press the OK button to complete the settings.

The menu disappears.

# SOUND SETTING

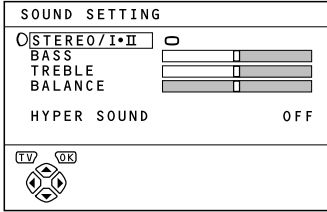

To display the **SOUND SETTING** menu:

- 1 Press the **OK** button to display **MENU** (main menu).
- 2 Press the **▼/▲** button to choose **SOUND SETTING**. Then press the **OK** button.

## ■ STEREO / I • II

When you are viewing a bilingual broadcast programme, you can choose the sound from Bilingual I (Sub I) or Bilingual II (Sub II). When the stereo broadcasting is received poorly, you can change from stereo to mono sound so that you can hear the broadcast more clearly and easily.

- 1 Press **▼/▲** buttons to choose **STEREO / I • II**.
- 2 Press **◀/▶** buttons to choose a sound mode.

- ∞ :Stereo sound
- :mono sound
- I :Bilingual I (sub I)
- II :Bilingual II (sub II)

- 3 Press the **OK** button to complete the setting.

The menu disappears.

**Note:**

- The sound mode you can choose differs depending on the TV programme.
- This function does not work in the **EXT** modes. And this function does not appear in the **SOUND SETTING** menu.

## ■ HYPER SOUND

You can enjoy sounds with a wider ambience.

- 1 Press **▼/▲** buttons to choose **HYPER SOUND**.

- 2 Press **◀/▶** buttons to choose **ON**.

To cancel the **HYPER SOUND** function:  
Press the **◀/▶** buttons to choose **OFF**.

- 3 Press the **OK** button to complete the setting.

The menu disappears.

**Note:**

- The **HYPER SOUND** function does not work properly with mono sound.
- You can turn on or off the **HYPER SOUND** function with a single press. For details, see "④ **HYPER SOUND** Button" on page 10.

## ■ Sound Adjustment

You can adjust the sound to your liking.

- 1 Press the **▼/▲** buttons to choose an item.
- 2 Press the **◀/▶** buttons to adjust it.

◀	Item	▶
Weaker	<b>BASS</b>	Stronger
Weaker	<b>TREBLE</b>	Stronger
Left	<b>BALANCE</b>	Right

- 3 Press the **OK** button to complete the setting.

The menu disappears.

# EXT SETTING

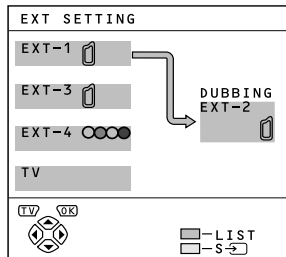

To display EXT SETTING menu:

- 1 Press the **OK** button to display MENU (main menu).
- 2 Press the **▼/▲** button to choose EXT SETTING. Then press the **OK** button.

## ■ S-V (S-VIDEO input)

When connecting a device (such as S-VHS VCR) which enables an S-VIDEO signal (Y/C signal) to be output, you can enjoy high-quality picture of the S-VIDEO signal (Y/C signal).

### Preparation:

- At first, read the Device Instruction Manual and "ADDITIONAL PREPARATION" on page 30 to connect the device to the TV properly. Second, follow the Device Instruction Manual to set the device so that a S-VIDEO signal (Y/C signal) can be output to the TV.
- Do not set **S-V** (S-VIDEO input) to the EXT terminal connected to a device which cannot output a S-VIDEO (Y/C signal). If it is set wrongly, a picture cannot appear.

- 1 Press the **▼/▲** buttons or **◀/▶** buttons to choose an EXT terminal.

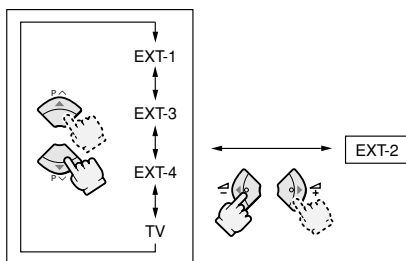

- 2 Press the yellow button and set the **S-V** (S-VIDEO input).

A **S-V** (S-VIDEO input) mark is displayed. You can view an S-VIDEO signal (Y/C signal) instead of the regular video signal (composite signal).

### To cancel the **S-V** (S-VIDEO input) setting:

Press the yellow button and turn off **S-V** (S-VIDEO input) mark.  
The regular video signal (composite signal) pictures are resumed.

- 3 Press the **OK** button to complete the setting.

The menu disappears.

### Note:

- The EXT-1 terminal does not support S-VIDEO signal (Y/C signal) and you cannot set **S-V** (S-VIDEO input) in the EXT-1 terminal.
- Setting **S-V** (S-VIDEO input) changes the head character from "E" to "S". For example, "E2" is changed to "S2".
- Even an device which enables the S-VIDEO signal (Y/C signal) to be output may output a regular video signal (composite signal) depending on the device setting. If a picture cannot appear because **S-V** (S-VIDEO input) setting has been made, read the device Instruction Manual carefully again to check for the device settings.

## ■ LIST

You can have a name corresponding to the devices connected for each EXT terminal. Giving a name to an EXT terminal makes the EXT terminal number appear on the screen, together with the name.

- 1 Press the **▼/▲** buttons or **◀/▶** buttons to choose an EXT terminal.

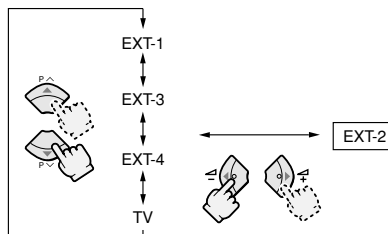

- 2 Press the blue button to display the name list (LIST).

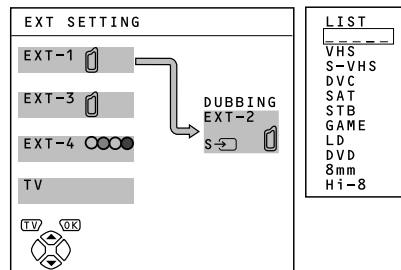

**3 Press the ▼/▲ buttons to choose a name.  
Then press the OK button.**

The LIST disappears and the name is assigned to the EXT terminal.

**To erase a name assigned to the EXT terminal:**

Choose a blank space.

**4 Press the OK button to complete the setting.**

The menu disappears.

---

**Note:**

- You cannot assign an EXT terminal name not found in the name list (LIST).
- 

## ■ DUBBING

You can choose a signal source to be output from an EXT-2 terminal.

You can choose any one of the output signals of the device connected to the EXT terminal and the picture and sound from a TV channel you are currently viewing to output it to the EXT-2 terminal.

**1 Press the ◀/▶ buttons to choose the EXT-2 terminal.**

**2 Press the ▼/▲ buttons to choose an EXT terminal or TV.**

The arrow in the menu represents a signal flow. The left side of the arrow denotes a signal source output from the EXT-2 terminal.

**EXT-1/EXT-3/EXT-4:**

The output signal of the device connected to an EXT terminal passes through the TV and is output from the EXT-2 terminal.

**TV:**

The picture and sound of the TV channel you are currently viewing are output from the EXT-2 terminal.

**3 Press the OK button to complete the setting.**

The menu disappears.

---

**Note:**

- During dubbing, you cannot turn off the TV. Turning off the TV also turns off the output from the EXT-2 terminal.
  - When you choose an EXT terminal as an output, you can view a TV programme or a picture from the other EXT terminal while dubbing the picture from a device connected to the EXT terminal onto a VCR connected to the EXT-2 terminal.
  - The RGB signals from TV games cannot be output. Teletext programmes cannot be output.
-

# FEATURES

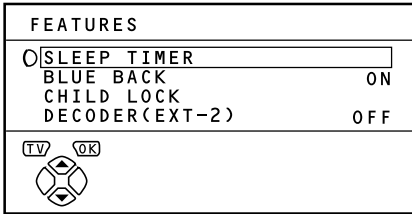

To display the **FEATURES** menu:

- 1 Press the **OK** button to display **MENU** (main menu).
- 2 Press the **▼/▲** button to choose **FEATURES**. Then press the **OK** button.

## ■ SLEEP TIMER

You can set the TV to automatically turn off after a specified period of time.

- 1 Press the **▼/▲** buttons to choose **SLEEP TIMER**. Then press the **OK** button.

A Sub-menu of the **SLEEP TIMER** function appears.

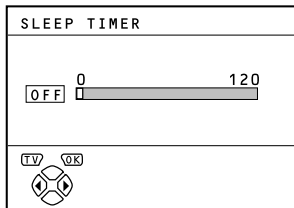

- 2 Press the **◀/▶** buttons to set the period of time.

You can set the period of time a maximum of 120 minutes (2 hours) in 10 minute increments.

**To cancel the SLEEP TIMER function:**

Press the **◀** button to set a period of time to "OFF."

- 3 Press the **OK** button to complete the settings.

The menu disappears.

### Note:

- One minute before the **SLEEP TIMER** function turns off the TV, "GOOD NIGHT!" appears.
- The **SLEEP TIMER** function cannot be used to turn off the TV's main power.
- When the **SLEEP TIMER** function is on, you can display the Sub-menu of the **SLEEP TIMER** function again to confirm and/or change the remaining period of time of the **SLEEP TIMER** function. Press the **OK** button to exit the menu after confirming and / or changing the remaining time.

## ■ BLUE BACK

You can set the TV to automatically change to a blue screen and mute the sound if the signal is weak or absent, or when there is no input from an external device.

- 1 Press the **▼/▲** buttons to choose **BLUE BACK**.
- 2 Press the **◀/▶** buttons to choose **ON**.

**To cancel the BLUE BACK function:**

Press the **◀/▶** buttons to choose **OFF**.

- 3 Press the **OK** button to complete the setting.

The menu disappears.

## ■ CHILD LOCK

When there is a TV channel you wish your children not to watch, you can use the **CHILD LOCK** function to lock out the TV channel. Even when a child chooses a Programme number (PR) in which a locked TV channel has been registered, the screen will change to blue and displays **Ⓜ** (**CHILD LOCK**) so the TV channel cannot be viewed. Unless you enter a pre-set ID number by a special operation, the lock cannot be released and the child cannot view the TV channel programs.

### To set the CHILD LOCK function

- 1 Press the **▼/▲** buttons to choose **CHILD LOCK**. Then press the **0 (AV)** button.

"SET ID NO." (ID number setting screen) appears.

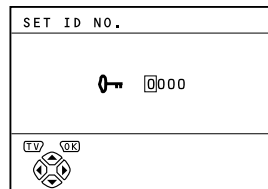

- 2 Set the ID number to your liking.

- 1 Press the **▼/▲** buttons to choose a number.
- 2 Press the **◀/▶** buttons to move the cursor.

- 3 Press the **OK** button.

The Sub-menu of **CHILD LOCK** appears.

CHILD LOCK		
PR	ID	CH / CC
AV		
1	BBC1	CH 21
2		CH 22
3		CH 23
4		CH 24
5		CH 25
6		CH 26
7		CC 01
8		CC 02
9		CC 03

Navigation buttons (TV, OK) and a directional pad are shown at the bottom. A small box labeled '- LOCK' is visible at the bottom right.

- 4 Press the **▼/▲** buttons to choose a TV channel.

Every time you press the **▼/▲** buttons, the Programme number (PR) changes, and the picture of the TV channel registered in the Programme number (PR) is displayed on the screen.

**5 Press the blue button and set the CHILD LOCK function.**

🔒 (CHILD LOCK) appears and the TV channel is locked.

**To reset the CHILD LOCK function:**

Press the blue button again.

🔒 (CHILD LOCK) disappears.

**6 Press the OK button to complete the setting.**

The menu disappears.

**Note:**

- To disable easy resetting of the CHILD LOCK function, the menu disappears by choosing the CHILD LOCK function and pressing the OK button as in the ordinary menu operation.

**■ DECODER (EXT-2)**

Only when connecting a Decoder with a T-V LINK compatible VCR connected to the EXT-2 terminal, you can use this function. To operate this function, see "Using the DECODER (EXT-2) function" on page 28.

**Caution:**

- If you have not connected a Decoder with a T-V LINK compatible VCR connected to the EXT-2 terminal, setting this function to "ON" by mistake causes the picture/sound of a TV channel you are currently viewing not to be issued.

**To view a locked TV channel**

**1 Choose a Programme number (PR) in which a TV channel locked with the Number buttons or PR LIST.**

The screen changes to blue and the 🔒 (CHILD LOCK) appears. You cannot view the TV channel.

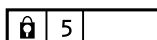

**2 Press the ⓘ (Information) button to display "ID NO." (ID No. input screen).**

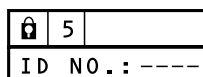

**3 Press the Number buttons to enter the ID number.**

The lock is temporarily released so you can view the TV channel.

**If you have forgotten the ID number:**

Perform step 1 of "To set the CHILD LOCK function". After confirming the ID number, press the TV button to exit the menu.

**Note:**

- Even if you reset the lock temporarily, it does not mean that the CHILD LOCK function set for the TV channel is cancelled. The next time anyone attempts to view the TV channel, it will be locked again.
- When you would like to cancel the CHILD LOCK function, you must perform the operation "To set the CHILD LOCK function" again.
- To disable easy choosing of a Programme number (PR) in which a locked TV channel has been registered, the Programme number (PR) has been set that it cannot be chosen by the ▼/▲ buttons or the operation buttons at the TV.
- To disable easy resetting of the lock, "ID NO." (ID No. input screen) is set so that it cannot appear unless you press the ⓘ (Information) button.

# INSTALL

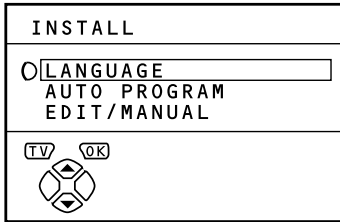

To display the **INSTALL** menu:

- 1 Press the **OK** button to display **MENU** (main menu).
- 2 Press the **▼/▲** button to choose the **INSTALL** menu. Then press the **OK** button.

## LANGUAGE

You can choose the language you want to use for the on-screen display from the language list in a menu.

- 1 Press the **▼/▲** buttons to choose **LANGUAGE**. Then press the **OK** button.

A sub-menu of the **LANGUAGE** function appears.



- 2 Press the **▼/▲** buttons to choose a language.
- 3 Press the **OK** button to complete the setting.

The menu disappears.

## AUTO PROGRAM

You can automatically register the TV channels which can be received well at your residence in the TV's Programme numbers (PR) by performing the following.

- 1 Press the **▼/▲** buttons to choose **AUTO PROGRAM**. Then press the **OK** button.

The **COUNTRY** menu appears as a sub-menu of the **AUTO PROGRAM** function.

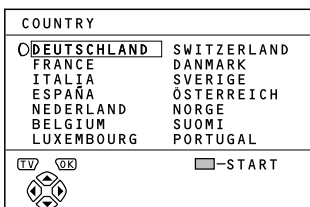

- 2 Press the **◀/▶** and **▼/▲** buttons to choose the country where you are now located.

- 3 Press the **blue** button to start the **AUTO PROGRAM** function.

The **AUTO PROGRAM** menu appears and received TV channels are automatically registered in the Programme numbers (PR).

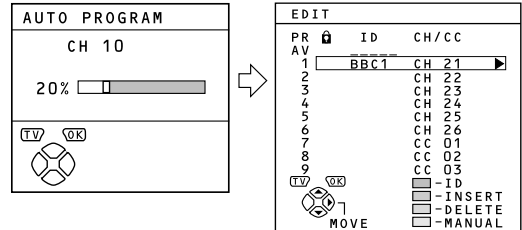

To cancel the **AUTO PROGRAM** function:

Press the **TV** button.

- 4 After the TV channels have been registered in the Programme numbers (PR), the **EDIT** menu appears.

You can proceed to edit the Programme numbers (PR) using the **EDIT/MANUAL** function. For details, see "EDIT/MANUAL" on page 24.

**When not using the EDIT/MANUAL function:**

If you do not need to use the **EDIT/MANUAL** function, go to the next step.

- 5 Press the **OK** button to display the **T-V LINK** menu.

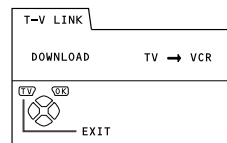

- 6 Operate the **T-V LINK** menu according to the type of **VCR** connected to the **EXT-2** terminal.

**When a T-V LINK compatible VCR is not connected:**

Press the **TV** button to exit the **T-V LINK** menu.

The **T-V LINK** menu disappears, and all the settings are completed.

**When a T-V LINK compatible VCR is connected:**

Follow the operating procedure "Downloading the data to VCR" on page 28 to transmit the Programme number (PR) data to the VCR.

**Note:**

- When your TV can detect the TV channel name from the TV channel broadcast signal, it automatically registers the TV channel name (ID) to the Programme number (PR) in which the TV channel has been registered.
- If a TV channel you want to view is not set to a Programme number (PR), manually set it using the **MANUAL** function. For details, see "EDIT/MANUAL" on page 24.
- The TV channel is not registered in Programme number PR 0 (AV). When you want to register a TV channel to PR 0 (AV) manually set it using the **MANUAL** function. For details, see "EDIT/MANUAL" on page 24.



## ■ EDIT/MANUAL

The EDIT/MANUAL functions are divided into two types: editing of the current Programme numbers (PR) (EDIT functions) and manual registration of a TV channel you want to view to the Programme number (PR) (MANUAL function). The details about these functions are as follows:

### MOVE:

This function changes a Programme number (PR) of a TV channel.

### ID:

This function registers a Channel name (ID) to a TV channel.

### INSERT:

This function adds a new TV channel in the current Programme numbers (PR) list by using the CH/CC number.

### DELETE:

This function deletes an unnecessary TV channel.

### MANUAL:

This function manually registers a new TV channel in a Programme number (PR).

### Caution:

- Using the MOVE, DELETE or INSERT function rewrites the current Programme numbers (PR) list. Resultingly, the Programme number (PR) of some of the TV channels will change.
- Using the MANUAL function for a TV channel for which the CHILD LOCK function has been set cancels the CHILD LOCK function for the TV channel.
- Using the MANUAL function for a TV channel for which the DECODER (EXT-2) function has been set to ON returns the setting of the DECODER (EXT-2) function for the TV channel to OFF.
- When a TV channel has already been registered in PR 99, using the INSERT function deletes the TV channel.

### Note:

- For Programme number PR 0, "AV" appears in the Programme numbers (PR) list.
- An EXT terminal number does not appear in the Programme numbers (PR) list.
- The CH/CC number is a number unique to the TV and corresponding to the Channel number of a TV channel. For the relationship of a Channel number and a CH/CC number, see "CH/CC NUMBER" on page 32.
- You cannot use the INSERT function if you do not know a Channel number of a TV channel. Use the MANUAL function to register a TV channel in the Programme number (PR).

- 1 Press the **▼/▲** buttons to choose EDIT/MANUAL. Then press the **OK** button.

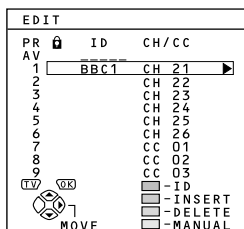

- 2 Follow the operation description of a function you want to use and operate the function.

- 3 Press the **OK** button to complete the settings.

The T-V LINK menu appears.

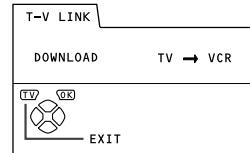

- 4 Operate the T-V LINK menu according to the type of VCR connected to the EXT-2 terminal.

**When a T-V LINK compatible VCR is not connected:**

Press the **TV** button to exit the T-V LINK menu.

The T-V LINK menu disappears and all the settings are completed.

**When a T-V LINK compatible VCR is connected:**

Follow the operating procedure "Downloading the data to VCR" on page 28 to transmit the Programme number (PR) data to the VCR.

## MOVE

- 1 Press the **▼/▲** buttons to choose a TV channel.

Every time you press the **▼/▲** buttons, the Programme number (PR) is changed over, and the picture of the TV channel registered in the Programme number (PR) appears on the screen.

- 2 Press the **▶** button to start the MOVE function.

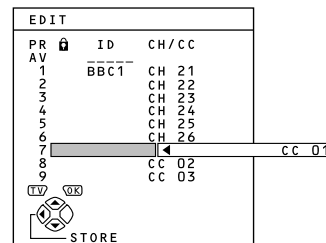

- 3 Press the **▼/▲** buttons to choose a new Programme number (PR).

**To cancel the MOVE function:**

Press the **i** (Information) button.

- 4 Press the **◀** button to change the Programme number (PR) of a TV channel to a new Programme number (PR).

## ID

### 1 Press the ▼/▲ buttons to choose a TV channel.

Every time you press the ▼/▲ buttons, the Programme number (PR) is changed over, and the picture of the TV channel registered in the Programme number (PR) appears on the screen.

### 2 Press the red button to start the ID function.

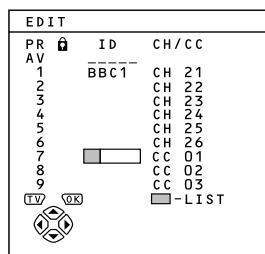

### 3 Press the ▼/▲ buttons to choose the first character of a Channel name (ID) you want to attach to the TV channel.

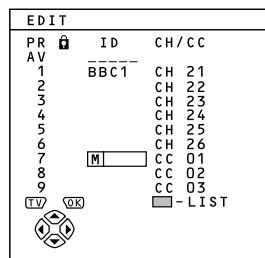

### 4 Press the blue button to display the ID LIST (channel name list).

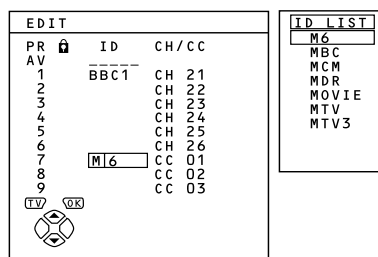

### 5 Press the ▼/▲ buttons to choose the Channel name (ID).

**To cancel the ID function:**

Press the ⓘ (Information) button.

### 6 Press the OK button to register a Channel name (ID) to a TV channel.

#### Note:

- You can register your unique Channel name (ID) to the TV channel. When step 3 is completed, do not go to step 4, but press the ◀▶ buttons to move the cursor and the ▼/▲ buttons to choose a character for completing the Channel name (ID). Then press the OK button to register the Channel name (ID) to the TV channel.

## INSERT

#### Preparation:

- A CH/CC number unique to this TV and corresponding to the Channel number of a TV channel is required. Find the corresponding CH/CC number from a table "CH/CC NUMBER" on page 32, based on the Channel number of the TV channel.
- When the COUNTRY setting is not FRANCE, use a two-digit CH/CC number. When the COUNTRY setting is FRANCE, use a three-digit CH/CC number.
- Only when you add a TV channel (SECAM-L system) from a French station, be sure to set COUNTRY to FRANCE. If the COUNTRY setting is not FRANCE, follow the description "Changing the COUNTRY setting" on page 28 to change the COUNTRY setting to FRANCE, then start the INSERT function.

### 1 Press the ▼/▲ buttons to choose a Programme number (PR) for which you will register a new TV channel.

### 2 Press the green button and start the INSERT function.

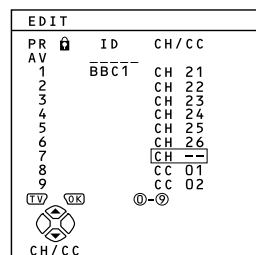

### 3 Press the ▼/▲ buttons to choose "CC" or "CH" according to the CH/CC number of the TV channel.

**When the COUNTRY setting is FRANCE:**

Choose "CH1", "CH2", "CC1" or "CC2".

**To cancel the INSERT function:**

Press the ⓘ (Information) button.

### 4 Press the Number buttons to enter the remaining CH/CC number.

The TV shifts to registration mode.

When the registration is completed, the picture of the TV channel appears on the screen.

#### Note:

- The CH/CC number is a number indicating the broadcast frequency to the TV. If the TV cannot detect the TV channel corresponding to the broadcast frequency indicated by the CH/CC number, a picture in the no-signal state appears.

## DELETE

### 1 Press the ▼/▲ buttons to choose a TV channel.

Every time you press the ▼/▲ buttons, the Programme number (PR) is changed over, and the picture of the TV channel registered in the Programme number (PR) appears on the screen.

### 2 Press the yellow button to delete the TV channel.

The TV channel is deleted from the Programme numbers (PR) list.

## MANUAL

### Preparation:

- As long as you register the TV channel (SECAM-L system) from a French station, be sure to set the COUNTRY setting to FRANCE. If the COUNTRY setting is not FRANCE, follow the description "Changing the COUNTRY setting" on page 28 to change the COUNTRY setting to FRANCE, then start the MANUAL function.

### 1 Press the ▼/▲ buttons to choose a Programme number (PR) to which you want to register a new TV channel.

### 2 Press the blue button to activate the MANUAL function.

At the right side following the CH/CC number, the SYSTEM (broadcasting system) of the TV channel appears.

EDIT		
PR	ID	CH/CC
AV		
1	BBC1	CH 21
2		CH 22
3		CH 23
4		CH 24
5		CH 25
6		CH 26
7		CC 01 (B/G)
8		CC 02
9		CC 03
137		
SYSTEM		

### To cancel the MANUAL function:

Press the ⓘ (Information) button.

### 3 Press the ► button to choose the SYSTEM (broadcasting system) for a TV channel you want to register.

#### TV channel (SECAM-L system) from a French station:

Set the SYSTEM to "L". If it is set to one other than "L", you cannot receive the TV channel of the SECAM-L system.

### Other TV channels:

If you do not know the correct broadcasting system, set the SYSTEM to "B/G". If "B/G" is not correct, it results in the fact that you will not hear the sound normally when the TV detects a TV channel. In this case, retry to set the SYSTEM again correctly so that no problem arises.

### 4 Press the green or red button to search for a TV channel.

Scanning stops when the TV finds a TV channel. Then the TV channel is displayed.

### 5 Press the green or red button repeatedly until the TV channel you want appears.

#### If the TV channel reception is poor:

Press the blue or yellow button to fine-tune the TV channel.

#### If you cannot hear the normal sound even when the picture of the TV channel appears normally:

The SYSTEM setting is wrong. Press the ► button and choose a SYSTEM that has normal sound.

### 6 Press the OK button and register the TV channel to a Programme number (PR).

The normal EDIT menu is resumed.

# DEMO

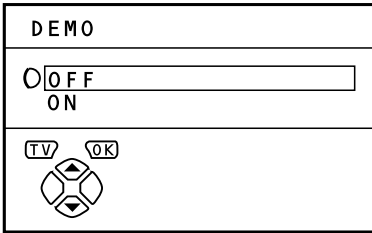

*To display the DEMO menu:*

- 1 Press the OK button to display MENU (main menu).**
- 2 Press the ▼/▲ button to choose DEMO. Then press the OK button.**

The DEMO function automatically demonstrates some of the TV functions.

- 1 Press the ▼/▲ buttons to choose ON.**
- 2 Press the OK button to complete the settings.**

The DEMO function is set to ON, and the demonstration will start.

***To stop the demonstration:***

Press one of the buttons on the remote control.

***When the DEMO function is set to ON:***

Each time the TV is turned on, the demonstration starts automatically. If you do not want that to happen, perform the following operations to cancel the DEMO function:

- 1 Display the DEMO menu again.**
- 2 Press the ▼/▲ buttons to choose OFF.**
- 3 Press the OK button to cancel the DEMO function.**

# ADDITIONAL MENU OPERATIONS

## ■ Downloading the data to VCR

You can transmit to the latest Programme numbers (PR) data to the VCR with the T-V LINK function.

### Caution:

- Only when the T-V LINK compatible VCR is connected to the EXT-2 terminal, this operation is enabled.
- Only when the T-V LINK menu is being displayed, this operation is enabled.

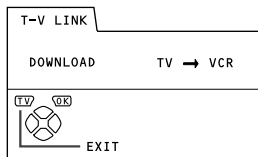

### 1 Turn on the VCR.

### 2 Press the OK button.

The data transmission begins.

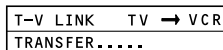

The T-V LINK menu disappears once the data transmission ends.

### When the T-V LINK menu is changed over to another menu:

The menu operation at the TV side is completed and it is shifted to the menu operation at the VCR side. Refer to the VCR Instruction Manual and operate the VCR.

### Note:

- If "FEATURE NOT AVAILABLE" appears at the T-V LINK menu, ensure the following three items are correct; then press the OK button to retry data transmission.
  - Has the T-V LINK compatible VCR been connected to the EXT-2 terminal?
  - Has the VCR power been turned on?
  - Does the SCART cable that is connected to the EXT-2 terminal to T-V LINK compatible VCR have all proper connections?

## ■ Changing the COUNTRY setting

After the AUTO PROGRAM function is completed, you can change the country you have already set by using the AUTO PROGRAM function.

When registering the TV channels for French broadcast stations (SECAM-L system), perform this operation to change the country.

### 1 Display the INSTALL menu.

#### When the EDIT menu is currently being displayed:

Press the **i** (Information) to return to the INSTALL menu.

### 2 Press the ▼/▲ buttons to choose AUTO PROGRAM. Then press the OK button.

A COUNTRY menu appears as a sub-menu of the AUTO PROGRAM function.

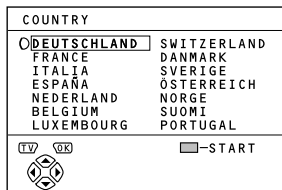

### 3 Press the ◀/▶ and the ▼/▲ buttons to choose a country.

### 4 Press the OK button to complete the setting.

The menu disappears.

To return to the INSTALL menu from the COUNTRY menu:

Press the **i** (Information) button instead of the OK button.

## ■ Using the DECODER (EXT-2) function

When connecting a Decoder with a T-V LINK compatible VCR connected to the EXT-2 terminal, use the DECODER (EXT-2) function to unscramble the scrambled TV channels.

### 1 Turn on the Decoder power.

### 2 Display the TV channel capable of being unscrambled with the Decoder on the TV.

Even if the Decoder is functioning, a scrambled picture appears at this time.

### 3 Press the OK button to display the MENU.

The MENU (main menu) appears.

### 4 Press the ▼/▲ buttons to choose FEATURES. Then press the OK button.

The FEATURES menu appears.

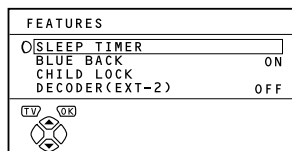

### 5 Press the ▼/▲ buttons to choose DECODER (EXT-2). Then press the ◀/▶ buttons to choose ON.

An unscrambled picture appears.

To cancel the DECODER (EXT-2) function:

Press the ◀/▶ buttons to choose OFF.

**6 Press the OK button to complete the setting.**

The T-V LINK menu appears.

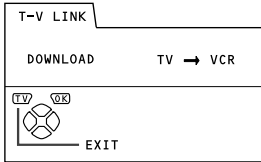

**7 Follow the operating procedure “Downloading the data to VCR” on page 28 to transmit the Programme number (PR) data to the VCR.**

**8 If you have another TV channel capable of being unscrambled with a Decoder, repeat steps 2 through 7.**

**Note:**

- If for some reason the DECODER (EXT-2) function has been set to “ON” but the TV channel cannot be unscrambled, check the following:
  - Has the Decoder been connected to the VCR properly according to the VCR and Decoder Instruction Manuals?
  - Has the Decoder power been turned on?
  - Can the TV channel be unscrambled with a Decoder?
  - Is it necessary to change the VCR settings in order to connect the Decoder? Confirm that the VCR is set properly by rechecking the VCR Instruction Manual.

# ADDITIONAL PREPARATION

## ■ Connecting the external devices

Connect the devices to the TV, paying attention to the Rear panel connections and the Front panel connections.

### Before connecting anything:

- Read the manuals provided with the devices. Depending on the devices, the connection method may differ from the figure. In addition, the device settings may be changed depending on the connection method to secure proper operation.
- Turn off all the devices including the TV.
- The "SPECIFICATIONS" on page 36 contains the details of the EXT terminals. If you are connecting a device not listed in the following connection diagram, see the table to choose the best EXT terminal.
- Note that connecting cables are not supplied.

- ① VCR (composite signal)
- ② VCR (composite signal/S-VIDEO signal)
- ③ T-V LINK compatible VCR (composite signal/S-VIDEO signal)
- ④ Decoder
- ⑤ DVD player (composite signal/S-VIDEO signal)
- ⑥ DVD player (composite signal/RGB signal)
- ⑦ TV game (composite signal/RGB signal)
- ⑧ TV game (composite signal/S-VIDEO signal)
- ⑨ Headphones
- ⑩ Camcorder (composite signal/S-VIDEO signal)
- ⑪ SCART cable
- ⑫ Audio cable
- ⑬ Video cable
- ⑭ S-VIDEO cable

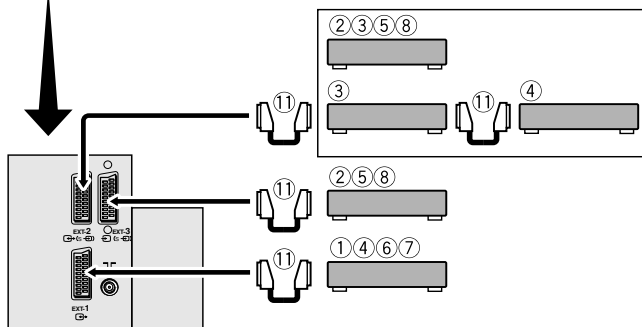
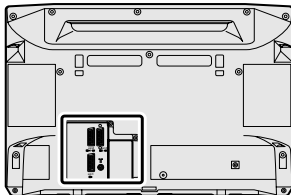
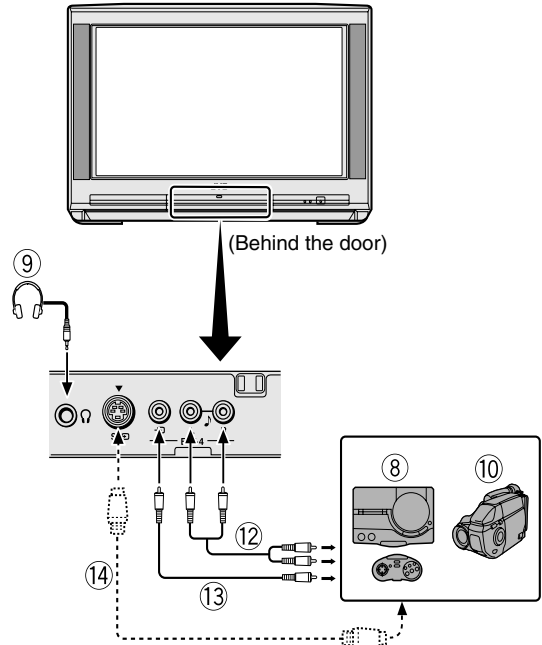

## Devices which can output the S-VIDEO signal (Y/C signal) such as a S-VHS VCR

Connect the device to an EXT terminal other than the EXT-1 terminal.

You can choose a video input signal from the S-VIDEO signal (Y/C signal) and regular video signal (composite signal). For details of how to operate the device, see "S-VIDEO input)" on page 19.

## T-V LINK compatible VCR

Be sure to connect the T-V LINK compatible VCR to the EXT-2 terminal. If not, the T-V LINK function will not work properly.

### Note:

- When connecting a T-V LINK compatible VCR to the EXT-2 terminal, be sure to connect the Decoder to the VCR. If not, the T-V LINK function may not work properly. After you have registered TV channels to the Programme numbers (PR), set the DECODER (EXT-2) function for the Programme number (PR) to ON in order to unscramble a scrambled TV channel. For details of operation, see "Using the DECODER (EXT-2) function" on page 28.

## Connecting headphones

Connect the headphones with a stereo mini-jack (of 3.5mm in diameter) to the headphone jack at the TV front panel.

### Note:

- When you connect the headphones, the TV speakers issue no sound.

## Video/sound signal output from the EXT-2 terminal

You can arbitrarily change over the output of the video/sound signal from the EXT-2 terminal. It is useful when you want to dub the video/sound from another device on the VCR connected to the EXT-2 terminal. For details on how to do this operation, see "DUBBING" on page 20.

## TV output from the EXT-1 terminal

The output of video/sound signal of a TV channel you are currently viewing is always output from the EXT-1 terminal.

### Note:

- Changing over a Programme number (PR) also changes over the TV output from the EXT-1 terminal.
- The video/sound signal from an EXT terminal cannot be output.
- Teletext programmes cannot be output.



# CH/CC NUMBER

When you want to use the INSERT function on page 25, find the CH/CC number corresponding to the Channel number of the TV channel from this table.

CH	Channel	CH	Channel	CC	Channel	CC	Channel
CH 02 / CH 202	E2	CH 40 / CH 240	E40	CC 01 / CC 201	S1	CC 31 / CC 231	S31
CH 03 / CH 203	E3, ITALY A	CH 41 / CH 241	E41	CC 02 / CC 202	S2	CC 32 / CC 232	S32
CH 04 / CH 204	E4, ITALY B	CH 42 / CH 242	E42	CC 03 / CC 203	S3	CC 33 / CC 233	S33
CH 05 / CH 205	E5, ITALY D	CH 43 / CH 243	E43	CC 04 / CC 204	S4	CC 34 / CC 234	S34
CH 06 / CH 206	E6, ITALY E	CH 44 / CH 244	E44	CC 05 / CC 205	S5	CC 35 / CC 235	S35
CH 07 / CH 207	E7, ITALY F	CH 45 / CH 245	E45	CC 06 / CC 206	S6	CC 36 / CC 236	S36
CH 08 / CH 208	E8	CH 46 / CH 246	E46	CC 07 / CC 207	S7	CC 37 / CC 237	S37
CH 09 / CH 209	E9, ITALY G	CH 47 / CH 247	E47	CC 08 / CC 208	S8	CC 38 / CC 238	S38
CH 10 / CH 210	E10, ITALY H	CH 48 / CH 248	E48	CC 09 / CC 209	S9	CC 39 / CC 239	S39
CH 11 / CH 211	E11, ITALY H+1	CH 49 / CH 249	E49	CC 10 / CC 210	S10	CC 40 / CC 240	S40
CH 12 / CH 212	E12, ITALY H+2	CH 50 / CH 250	E50	CC 11 / CC 211	S11	CC 41 / CC 241	S41
CH 21 / CH 221	E21	CH 51 / CH 251	E51	CC 12 / CC 212	S12	CC 75 / CC 275	X
CH 22 / CH 222	E22	CH 52 / CH 252	E52	CC 13 / CC 213	S13	CC 76 / CC 276	Y
CH 23 / CH 223	E23	CH 53 / CH 253	E53	CC 14 / CC 214	S14	CC 77 / CC 277	Z, ITALY C
CH 24 / CH 224	E24	CH 54 / CH 254	E54	CC 15 / CC 215	S15	CC 78 / CC 278	Z+1
CH 25 / CH 225	E25	CH 55 / CH 255	E55	CC 16 / CC 216	S16	CC 79 / CC 279	Z+2
CH 26 / CH 226	E26	CH 56 / CH 256	E56	CC 17 / CC 217	S17		
CH 27 / CH 227	E27	CH 57 / CH 257	E57	CC 18 / CC 218	S18		
CH 28 / CH 228	E28	CH 58 / CH 258	E58	CC 19 / CC 219	S19		
CH 29 / CH 229	E29	CH 59 / CH 259	E59	CC 20 / CC 220	S20		
CH 30 / CH 230	E30	CH 60 / CH 260	E60	CC 21 / CC 221	S21		
CH 31 / CH 231	E31	CH 61 / CH 261	E61	CC 22 / CC 222	S22		
CH 32 / CH 232	E32	CH 62 / CH 262	E62	CC 23 / CC 223	S23		
CH 33 / CH 233	E33	CH 63 / CH 263	E63	CC 24 / CC 224	S24		
CH 34 / CH 234	E34	CH 64 / CH 264	E64	CC 25 / CC 225	S25		
CH 35 / CH 235	E35	CH 65 / CH 265	E65	CC 26 / CC 226	S26		
CH 36 / CH 236	E36	CH 66 / CH 266	E66	CC 27 / CC 227	S27		
CH 37 / CH 237	E37	CH 67 / CH 267	E67	CC 28 / CC 228	S28		
CH 38 / CH 238	E38	CH 68 / CH 268	E68	CC 29 / CC 229	S29		
CH 39 / CH 239	E39	CH 69 / CH 269	E69	CC 30 / CC 230	S30		

CH	Channel	CH	Channel	CC	Frequency (Mhz)	CC	Frequency (Mhz)
CH 102	F2	CH 141	F41	CC 110	116 - 124	CC 152	391 - 399
CH 103	F3	CH 142	F42	CC 111	124 - 132	CC 153	399 - 407
CH 104	F4	CH 143	F43	CC 112	132 - 140	CC 154	407 - 415
CH 105	F5	CH 144	F44	CC 113	140 - 148	CC 155	415 - 423
CH 106	F6	CH 145	F45	CC 114	148 - 156	CC 156	423 - 431
CH 107	F7	CH 146	F46	CC 115	156 - 164	CC 157	431 - 439
CH 108	F8	CH 147	F47	CC 116	164 - 172	CC 158	439 - 447
CH 109	F9	CH 148	F48	CC 123	220 - 228	CC 159	447 - 455
CH 110	F10	CH 149	F49	CC 124	228 - 236	CC 160	455 - 463
CH 121	F21	CH 150	F50	CC 125	236 - 244	CC 161	463 - 469
CH 122	F22	CH 151	F51	CC 126	244 - 252		
CH 123	F23	CH 152	F52	CC 127	252 - 260		
CH 124	F24	CH 153	F53	CC 128	260 - 268		
CH 125	F25	CH 154	F54	CC 129	268 - 276		
CH 126	F26	CH 155	F55	CC 130	276 - 284		
CH 127	F27	CH 156	F56	CC 131	284 - 292		
CH 128	F28	CH 157	F57	CC 132	292 - 300		
CH 129	F29	CH 158	F58	CC 133	300 - 306		
CH 130	F30	CH 159	F59	CC 141	306 - 311		
CH 131	F31	CH 160	F60	CC 142	311 - 319		
CH 132	F32	CH 161	F61	CC 143	319 - 327		
CH 133	F33	CH 162	F62	CC 144	327 - 335		
CH 134	F34	CH 163	F63	CC 145	335 - 343		
CH 135	F35	CH 164	F64	CC 146	343 - 351		
CH 136	F36	CH 165	F65	CC 147	351 - 359		
CH 137	F37	CH 166	F66	CC 148	359 - 367		
CH 138	F38	CH 167	F67	CC 149	367 - 375		
CH 139	F39	CH 168	F68	CC 150	375 - 383		
CH 140	F40	CH 169	F69	CC 151	383 - 391		

## Note:

- When two CH/CC numbers correspond to one Channel number, choose either one according to the current COUNTRY setting. When the COUNTRY setting is other than FRANCE, choose a two-digit CH/CC number. When the COUNTRY setting is FRANCE, choose a three-digit CH/CC number.
- Find the CH/CC number (CC110 to CC161) corresponding to the TV channel (SECAM-L system) from a French cable TV station, based on the broadcast frequency of the TV channel. When you do not know the broadcast frequency, please contact the cable TV station.
- The CH/CC numbers of CH102-CH169 and CC110-CC161 correspond to the TV channels being broadcast by a SECAM-L system. The other CH/CC numbers correspond to the TV channels being broadcast by a method other than a SECAM-L system.

# TV BUTTONS AND PARTS

## ■ Front Panel

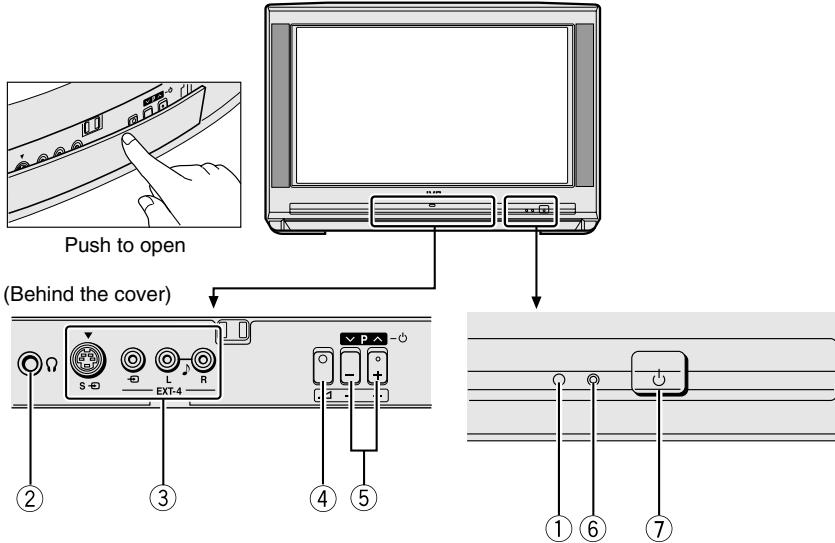

① Remote control sensor	
② Headphone jack (mini jack)	page 30
③ EXT-4 terminal	pages 19 and 30
④  (Volume) button	page 8

⑤ P   buttons	page 8
⑥ Power lamp	pages 3 and 6
⑦ Main power button	pages 3 and 6

### Caution:

- Do not grasp the TV by the front panel cover when moving the TV set. If you do, you may break the cover.

## ■ Rear Panel

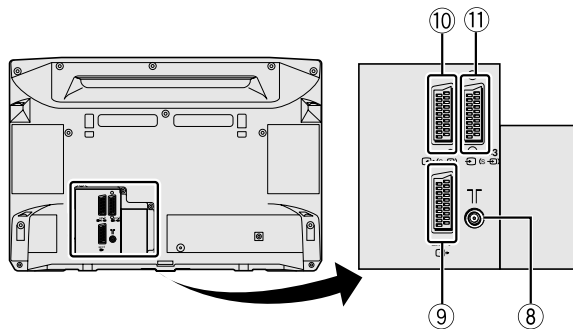

⑧ Aerial socket	page 2
⑨ EXT-1 terminal	pages 2, 19 and 30

⑩ EXT-2 terminal	pages 2, 5, 19 and 30
⑪ EXT-3 terminal	pages 19 and 30

# TROUBLESHOOTING

---

If a problem arises while you are using the TV, please read this "Troubleshooting" well before you request having the TV repaired. You may be able to fix it easily by yourself. For example, if the AC plug is disconnected from the AC outlet, or the TV aerial has problems, you may think there is a problem with the TV itself.

## Important:

- This Troubleshooting guide only covers problems whose cause are not easy to determine. If a question arises when you are operating a function, read the page(s) corresponding to the operation of the function well, not this Troubleshooting guide.
- After you have followed the Troubleshooting description or the operating description of the functions concerned without any success, remove the AC plug from the AC outlet and request a repair of your TV. Do not attempt to repair the TV by yourself or remove the rear cover of the TV.

## If you cannot turn on the TV

- Is the AC plug connected to the AC outlet?
- Is the Power lamp lit? If not, press the Main power button.

## No picture/No sound

- Have you chosen a TV channel whose reception is extremely bad? In this case, the BLUE BACK function will be activated, the entire screen becomes blue, and the sound is muted. In spite of this, if you want to view the TV channel, follow the description "BLUE BACK" on page 21 to try to change the BLUE BACK function setting to OFF.
- Have you connected the headphones to the TV? Connecting the headphones to the TV causes sounds not to be issued from the TV speakers.
- If the SYSTEM setting for a TV channel is incorrect, it may prevent the sound from being issued. Follow the description "EDIT/MANUAL" on page 24 to use the MANUAL function to try to change the SYSTEM setting.

## Poor picture

- If noise totally obscures the picture (snow), the aerial or aerial cable may have trouble. Check the following to try to solve the trouble:
  - Has the TV and aerial been connected properly?
  - Has the aerial cable been damaged?
  - Is the aerial pointed to the right direction?
  - Is the aerial itself faulty?
- If the TV or aerial receives interference from the other devices, stripes or noise may appear in the picture. Move such devices as an amplifier, personal computer, or a hair drier that can cause interference away from your TV, or try changing its location. If the aerial suffers interference from a radio tower or high-voltage wire, please contact your local dealer.
- If the TV receives interference from signals reflecting from mountains or building, double-pictures (ghosting) will occur. Try to change the aerial's direction or replace the antenna with the one with better directionality.
- Is your COLOUR SYSTEM setting for the TV channels correct? Follow the description "COLOUR SYSTEM" on page 16 to try to solve the trouble.

- Has COLOUR or BRIGHT been controlled properly? Follow the description "Picture Adjustment" on page 15 to try to adjust them properly.
- Videotaping teletext is not recommended because it may not record correctly.
- When a white and bright still image (such as a white dress) is displayed on the screen, the white part may look as if it is coloured. It is a phenomenon unavoidable due to the nature of the picture tube itself, and not due to a TV failure. When the picture disappears from the screen, the unnatural colours will also disappear.

## Poor sound

- Have you adjusted BASS or TREBLE properly? If not, follow the description "Sound Adjustment" on page 18 to try to adjust them properly.
- When the TV channel reception is poor, it can be hard to hear the stereo or bilingual sound. In this case, follow the description "STEREO / I•II" on page 18 to hear the sound more easily by changing it to a mono sound.

## Operation disabled

- Have the batteries of the remote control become exhausted? Follow the description "Putting Batteries into the Remote Control" on page 2 and replace them with new batteries to try to solve the problem.
- Have you attempted to use the remote control at the sides or rear of the TV or at a location more than seven meters apart from the TV location? Operate the remote control in the front of your TV or a location less than seven meters from your TV to try to solve the problem.
- When you are viewing a teletext programme, you cannot operate the menus. Press the TV button to return the teletext programme to the ordinary TV programme to try operating the menus.
- If the TV operation becomes disabled suddenly, press the Main power button on the TV and turn off the main power. Try to press the Main power button again to turn on the main power. If the TV returns to a normal state, it is not a failure.

## Other concerns

- When the SLEEP TIMER function operates, the TV is automatically turned off. If the TV is turned off suddenly, try to press the  (Standby) button to turn on the TV once again. At this time, if the TV resumes a normal state, there is no problem.
- When a WSS signal is included in the broadcast signal or the signal from an external device, or when the TV is receiving a control signal from an external device, the ZOOM mode will change automatically. When you want to return to the previous ZOOM mode, press the **ZOOM** button to choose the ZOOM mode again.
- If you bring a magnetised device such as a speaker near to your TV, a picture may be warped or unnatural colours appear at the corners of the screen. In this case, keep the device apart from your TV. If the speakers causes such phenomena, use the magnetic-shielded speakers instead.
- The TV may emit a crackling sound due to a sudden change in temperature. It does not matter if a picture or sound does not show any abnormality. If you hear crackling sounds frequently while you are viewing the TV, other causes may be assumed. For precautionary purposes, request your service technician to inspect it.
- Touching the screen may cause you to feel a slight electric shock due to its static electricity. It is an unavoidable phenomenon due to the construction of the picture tube. It is not a problem with the TV. You can rest assured that this static discharge does not have harmful influence over the human body.

# SPECIFICATIONS

Item	Model	AV28CT1EP*
Broadcasting systems		CCIR B/G, I, L
Colour systems		PAL, SECAM • The EXT terminals also support the NTSC 3.58/4.43 MHz system.
Channels and frequencies		• E2-E12, E21-E69, S1-S41, X, Y, Z, Z+1, Z+2, A-H, H+1, H+2, F2-F10, F21-F69 • French cable TV channel of broadcast frequencies 116 - 172 MHz and 220 - 469 MHz
Sound-multiplex systems		A2 (B/G), NICAM (B/G, I, L) system
Teletext systems		FLOF (Fastext), TOP, WST (World Standard System)
Power requirements		220 - 240 V AC, 50 Hz
Power consumption		Maximum: 156 W, Average: 122 W, Standby: 0.8 W
Picture tube size		Viewable area 66 cm (measured diagonally)
Audio output		Rated Power output: 5 W + 5 W
Speakers		(10 cm × 3 cm) oval × 2
EXT-1 terminal		Euroconnector (21-pin, SCART) • Video input, Audio L/R inputs and RGB inputs are available. • TV broadcast outputs (Video and Audio L/R) are available.
EXT-2 terminal		Euroconnector (21-pin, SCART) • Video input, S-VIDEO (Y/C) input and Audio L/R inputs are available. • Video and Audio L/R outputs are available. • T-V LINK functions are available.
EXT-3 terminal		Euroconnector (21-pin, SCART) • Video input, S-VIDEO (Y/C) input and Audio L/R inputs are available.
EXT-4 terminal		RCA connectors × 3 S-VIDEO connector × 1 • Video input, S-VIDEO (Y/C) input and Audio L/R inputs are available.
Headphone jack		Stereo mini-jack (3.5 mm in diameter)
Dimensions (W × H × D)		725 mm × 480 mm × 496 mm
Weight		33.8 kg
Accessories		Remote control unit × 1 (RM-C54 (Grey) or RM-C50 (Black) is supplied.) AAA/R03 dry cell battery × 2

\* A basic model number. The actual model number may have characters added (such as "S" denoting silver) indicating the colour of the TV set.

**Design and specifications subject to change without notice.**

Pictures displayed on the screen using this TV's ZOOM functions should not be shown for any commercial or demonstration purpose in public places (cafes, hotels, etc.) without the consent of the owners of copyright of the original picture sources, as this constitutes an infringement of copyright.



**JVC**



COLOUR TELEVISION

**COLOUR TELEVISION**

**AV28CT1EK**  
(UK model)

**AV28CT1EI**  
(Ireland model)

AV28CT1EK / AV28CT1EI

**Contents**

Safety precautions .....	2
Setting up your TV .....	4
T-V LINK functions .....	7
Using your TV—the basics .....	8
Remote control buttons and functions .....	11
Using the TV's menus .....	16
Picture setting .....	17
Picture features .....	18
Sound setting .....	20
EXT SETTING .....	21
FEATURES .....	23
INSTALL .....	25
DEMO .....	29
Other menus .....	30
Further preparation .....	31
TV buttons and parts .....	33
Troubleshooting .....	34
Specifications .....	35

*Natural Vision*  
**T-V LINK**



**INSTRUCTIONS**

**JVC**  
VICTOR COMPANY OF JAPAN, LIMITED

*plain English*  
*approved*  
by the word centre

Thank you for buying this **JVC** colour television.

To make sure you fully understand how to use your new TV, please read this manual thoroughly before you begin.

## Safety precautions

### ■ Warning

To prevent fire or shock hazard, do not expose this appliance to rain or moisture.

### ■ Caution

To ensure personal safety, observe the following rules regarding the use of this unit.

- 1 Operate only from the power source specified (AC 220 – 240 V, 50 Hz) on the unit.
- 2 Avoid damaging the mains plug and power cord.
- 3 Avoid improper installation and never position the unit where good ventilation is unattainable. When installing this television, distance recommendations must be maintained between the floor and wall, as well as installation in a tightly enclosed area or piece of furniture.

Please adhere to the minimum distance guidelines shown for safe operation.

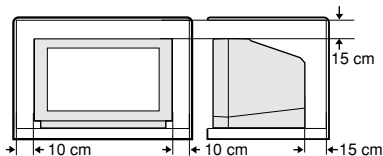

- 4 Do not allow objects or liquid into the cabinet openings.
- 5 In the event of a fault, unplug the TV and call a service technician. Do not attempt to repair it yourself or remove the rear cover.
- 6 The surface of the TV screen is easily damaged. Be very careful with it when handling the TV.  
Should the TV screen become soiled, wipe it with a soft dry cloth. Never rub it forcefully. Never use any cleaner or detergent on it.
- 7 The main power button on the TV does not fully isolate the TV from the mains supply. If you are not going to use this TV for a long period of time, be sure to disconnect the mains plug from the mains outlet.
- 8 Do not place any naked flame sources, such as lighted candles, on the apparatus.

### ■ Warning

**DO NOT cut off the mains plug from this equipment.** If the plug fitted is not suitable for the power points in your home or the cable is too short to reach a power point, then obtain an appropriate safety approved extension lead or adaptor or consult your dealer.

If nonetheless the mains plug is cut off, remove the fuse and dispose of the plug immediately, to avoid a possible shock hazard by inadvertent connection to the mains supply.

If a new mains plug has to be fitted, then follow the instruction given below:

### Important

**Do not** make any connection to the larger terminal which is marked with the letter E or by the safety earth symbol  $\perp$  or coloured green or green-and-yellow.

The wires in the mains lead on this product are coloured in accordance with the following code:

Blue: Neutral

Brown: Live

As these colours may not correspond with the coloured marking identifying the terminals in your plug proceed as follows:

The wire which is coloured blue must be connected to the terminal which is marked with the letter N or coloured black.

The wire which is coloured brown must be connected to the terminal which is marked with the letter L or coloured red.

When replacing the fuse only a correctly rated approved type should be used and be sure to re-fit the fuse cover.

**If in doubt — consult a competent electrician.**

### How to replace the fuse

Open the fuse compartment with a blade screwdriver, and replace the fuse.

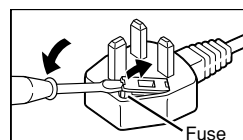

## ■ Guidelines for safe operation

This equipment has been designed and manufactured to comply with international safety standards. However, as with any electrical appliance, care must be taken to ensure optimal results and operational safety.

- Before attempting to use this equipment, read the operating instructions thoroughly.
- Ensure that all electrical connections (including the mains plug, extension leads, etc.) have been made in accordance with the manufacturer's instructions.
- If ever in doubt about the installation, operation or safety of this equipment, consult your dealer.
- Handle all glass panels or covers with care.
- Never operate this equipment if it appears damaged or operates abnormally. Turn the power off, disconnect the main power plug and consult your dealer.
- Never remove any affixed panels or covers. Doing so may result in electrical shock.
- Never leave this equipment operating unattended unless otherwise specifically stated that it is designed to do so or in standby mode. Only use the designated power switch to turn off the power and ensure that all potential users are instructed how to do so. Make special arrangements for infirm or handicapped persons.
- Never watch TV while operating a motor vehicle. It is illegal to watch TV while driving.
- Never listen to headphones at high volume. Doing so may damage your hearing.
- Never obstruct the ventilation of this equipment. Doing so may cause overheating and result in a malfunction or damage.
- Never use makeshift stands or attempt to affix legs with wood screws. When using a manufacturer's approved stand or legs, use only the fixtures provided and follow the installation instructions.
- Never allow this equipment to be exposed to rain or moisture.
- Never allow anyone, especially children, to insert anything into an opening in the case. Doing so may result in a fatal electrical shock.
- Never guess or take chances with electrical equipment of any kind. It is better to be safe than sorry.



# Setting up your TV

## ■ Connecting the aerial and video cassette recorder (VCR)

If you are connecting a VCR, follow

① → ② → ③ in the diagram opposite.

If you are not connecting a VCR, follow ①.

- For more details, see the manuals that came with the equipment you want to connect.
- The connecting cables are not provided.
- You can watch a video using the VCR without doing ③. For details, see your VCR instruction manual.
- To connect more equipment, please see "Further preparation" on page 31.
- If you connect a decoder to a T-V LINK compatible VCR, set the DECODER (EXT-2) function to ON. For details, see "Using the DECODER (EXT-2) function" on page 30. Otherwise, you will not be able to watch scrambled channels.

To use the T-V LINK functions, you must have a T-V LINK compatible VCR connected by a SCART cable ③ to the EXT-2 terminal on the TV. For details about T-V LINK functions, see "T-V LINK functions" on page 7.

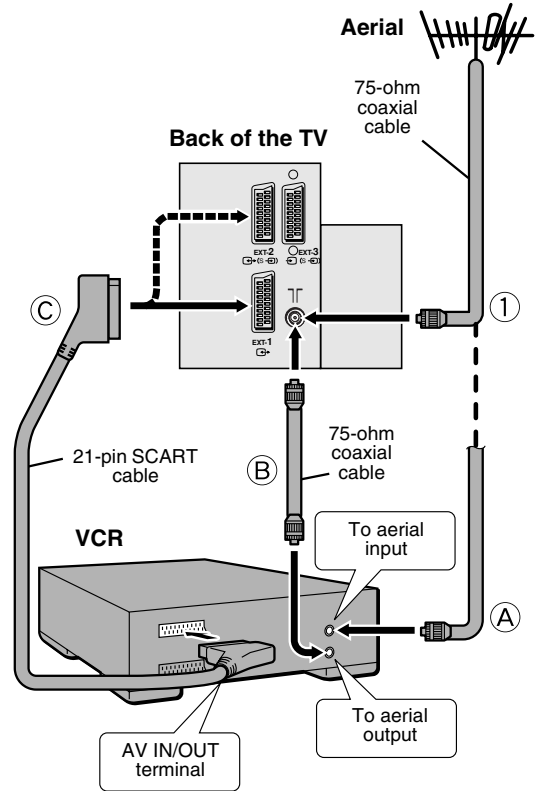

## ■ Connecting the power cord to the mains outlet

### Caution:

- Use only the power source specified on the unit (AC 220 – 240 V, 50 Hz).

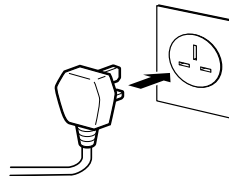

## ■ Putting batteries into the remote control

Use two AAA/R03 dry cell batteries.

Insert the batteries holding the ⊖ end, making sure the ⊕ and ⊖ terminals are correctly lined up.

To open the battery compartment, slide the door downwards and lift off. Replace the door by sliding it upwards until it fastens into place.

- Follow the warnings printed on the batteries.
- Battery life is about six months to one year, depending on how much you use the remote control.
- If the remote control does not work properly, fit new batteries.
- The batteries we supply are only for setting up and testing your TV. Please replace them as soon as you need to.
- Always use good-quality batteries.

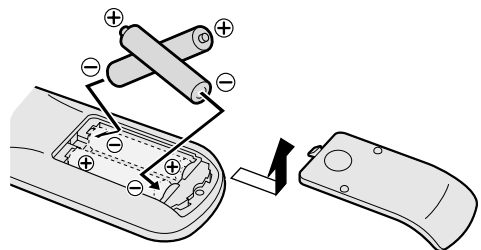



## ■ Initial settings

When the TV is first turned on, it goes into the initial setting mode, and you will see the JVC logo. Follow the instructions on the screen to make the initial settings.

### 1 Press the main power button on the TV

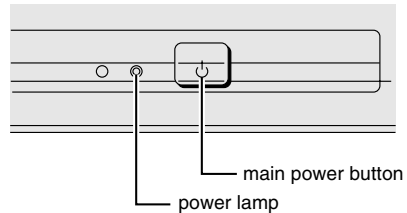
The power lamp lights red (for power on), then green (for TV on) and the JVC logo appears.



- If the power lamp stays red and does not change to green:  
your TV is in the standby mode. Press the  (standby) button on the remote control to turn your TV on.
- If the JVC logo does not appear this is because your TV has already been turned on for the first time:  
use the "LANGUAGE" and "AUTO PROGRAM" functions to make the initial settings. For details, see "INSTALL" on page 25.

### 2 Press the OK button

The LANGUAGE menu appears.



### 3 Press the and buttons to choose ENGLISH

The on-screen display will then be in English.

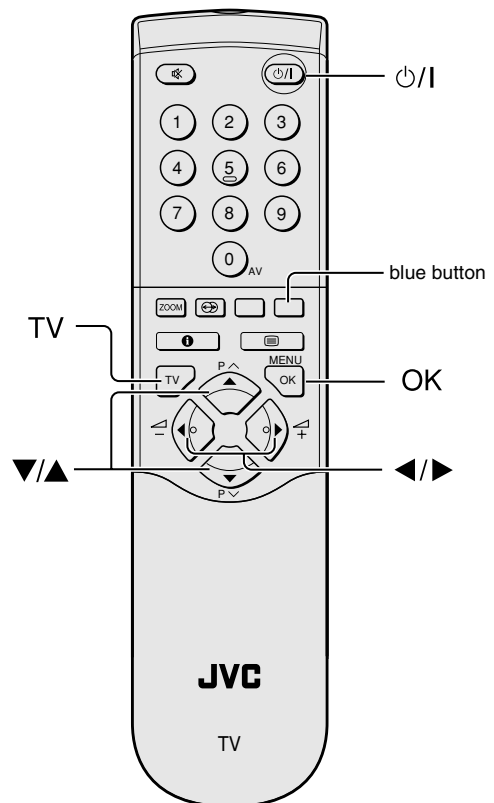

#### 4 Press the OK button to start the AUTO PROGRAM function

The AUTO PROGRAM menu appears and the TV channels you receive are automatically stored in the programme numbers list (PR).

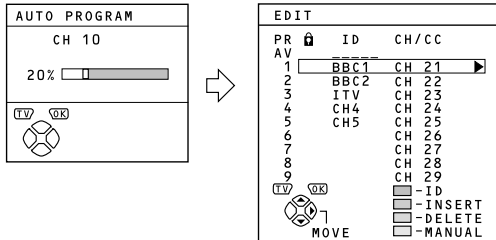

#### To cancel the AUTO PROGRAM function:

Press the TV button.

#### 5 After the TV channels have been registered in the programme numbers list (PR), the EDIT menu appears

If you want to, you can now edit the programme numbers (PR) using the EDIT/MANUAL function. For details, see "EDIT/MANUAL" on page 26.

If you do not want to edit programme numbers (PR), go to the next step.

#### 6 Press the OK button to display the T-V LINK menu

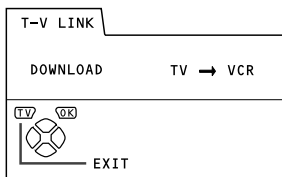

#### 7 Follow the T-V LINK menu according to the type of VCR you have connected to the EXT-2 terminal

##### If you do not have a T-V LINK compatible VCR connected:

Press the TV button to leave the T-V LINK menu.

The T-V LINK menu disappears.

##### If you have a T-V LINK compatible VCR connected:

Follow the operating procedure "Downloading data to a VCR" on page 30 to transmit the programme number (PR) data.

#### 8 Now, the initial settings are complete, and you can watch the TV

##### Note:

##### • For UK model (AV28CT1EK):

BBC1, BBC2, ITV, Channel 4 and Channel 5 are automatically set to the programme numbers PR1 to PR5.

If the TV doesn't receive one of these TV channels, that programme number (PR) will not be set. Programme number PR6 is not normally set.

##### • For Ireland model (AV28CT1EI):

If your TV can detect the TV channel name from the TV channel broadcast signal, the TV channel name is assigned to the programme number (PR) to which the TV channel has been set.

However, which TV channels are set to which programme numbers (PR) will depend on the area in which you live.

- If a TV channel you want to view is not set to a programme number (PR), you can set it using the MANUAL function. For details, see "EDIT/MANUAL" on page 26.
- The AUTO PROGRAM function does not set the programme number PR 0 (AV) for your video cassette recorder. You will need to set this using the MANUAL function.
- In some areas you may get TV reception from more than one transmitter, for example different ITV regions. In this case each TV channel could be set twice. If this happens, the first set of channels will have the stronger signal. If you want to delete the second set of channels, you will have to do it manually (see page 28).

##### For users in the UK:

If you have any problems setting up your new TV, please call the JVC Helpline on 0870 330 5000.

##### For users in the Republic of Ireland:

If you have any problems setting up your new TV, please contact your local JVC dealer.

# T-V LINK functions

---

When you have a T-V LINK compatible VCR connected to the EXT-2 Terminal on the TV, it is easier to set up the VCR and to view videos. T-V LINK uses the following features:

## ■ Pre-set download

The VCR will automatically download the registered data on the TV channels from the TV. This means you do not need to set up the program channels on your VCR manually. The preset download function automatically begins when the initial setting is complete or whenever you carry out the AUTO PROGRAM or EDIT/MANUAL functions.

You can also carry out this function using your VCR controls.

### When "FEATURE NOT AVAILABLE" is displayed:

If "FEATURE NOT AVAILABLE" is displayed, the download was not performed correctly. Before trying to download again, check that:

- the VCR power is turned on
- the VCR is T-V LINK compatible
- the VCR is connected to the EXT-2 terminal
- the SCART cable is fully wired

## ■ Direct Rec

"What You See Is What You Record"

You can easily record to VCR the images that you are watching on the TV.

For details, read the manual for your VCR. Use your VCR controls. "VCR IS RECORDING" is displayed.

**In the following situations, the VCR will stop recording if the TV is turned off, if the TV channel or input is changed, or if the menu is displayed on the TV:**

- when recording images from an external device connected to the TV (for example a camcorder)
- when recording a TV channel after it has been unscrambled on a decoder
- when recording a TV channel by using the TV's output because the VCR's own tuner cannot properly receive that channel
- You cannot carry out Direct Rec using your TV's control.
- Generally, the VCR cannot record a TV channel that it cannot receive properly on its own tuner, even if you can view that TV channel on the TV. However, some VCRs can record a TV channel by using the TV's output if that channel can be viewed on the TV. For details, see your VCR instruction manual.

## ■ TV auto power on/VCR image view

When the VCR starts playing, the TV automatically turns on and the images from the EXT-2 terminal appear on the screen.

When the VCR menu is operated, the TV automatically turns on and the images from the EXT-2 terminal appear on the screen.

This function does not happen if your TV's main power is turned off. Set your TV's main power to on (standby mode).

### Note:

- A "T-V LINK compatible VCR" means a JVC video cassette recorder with the T-V LINK logo, or with one of the following logos. However, these VCRs may support some or all of the features described earlier. For details, see your VCR instruction manual.

"Q-LINK" (a trademark of Panasonic Corporation)

"Data Logic" (a trademark of Metz Corporation)

"Easy Link" (a trademark of Phillips Corporation)

"Megalogic" (a trademark of Grundig Corporation)

"SMARTLINK" (a trademark of Sony Corporation)

# Using your TV—the basics

## ■ Turn the main power on

### Press the main power button on the TV

The power lamp lights red and your TV is in the standby mode.

If the power lamp lights green, the TV is already on.

#### To turn the main power off:

Press the main power button again.

The power lamp goes off.

The main power button on the TV does not fully cut the TV off from the mains supply. If you are not going to use this TV for a long time, be sure to pull the mains plug out of the mains outlet.

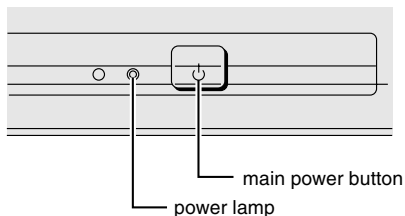

## ■ Turn the TV on from standby mode

### Press the $\text{P}/\text{I}$ (standby) button, the TV button, the $\nabla/\blacktriangle$ buttons or the number buttons

The power lamp goes from red to green and your TV will be turned on.

#### To turn the TV off:

Press the  $\text{P}/\text{I}$  (standby) button again.

The power lamp changes from green to red and the TV goes into standby mode.

## ■ Choose a TV channel

Choose the programme number (PR) that the TV channel has been set to.

#### Use the $\nabla/\blacktriangle$ buttons:

Press the  $\nabla/\blacktriangle$  buttons to choose the programme number (PR) you want.

#### Use the number buttons:

Enter the programme number (PR) of the channel using the number buttons.

#### Example

- PR12 → press 1 and 2.
- PR6 → press 6.

#### Use the PR LIST:

- 1 Press the  $\text{i}$  (information) button to display the PR LIST

PR	ID
AV	
1	BBC1
2	BBC2
3	ITV
4	CH4
5	CH5
6	
7	
8	
9	

$\text{i}$  TV  $\text{OK}$   $\nabla/\blacktriangle$  -10 +10

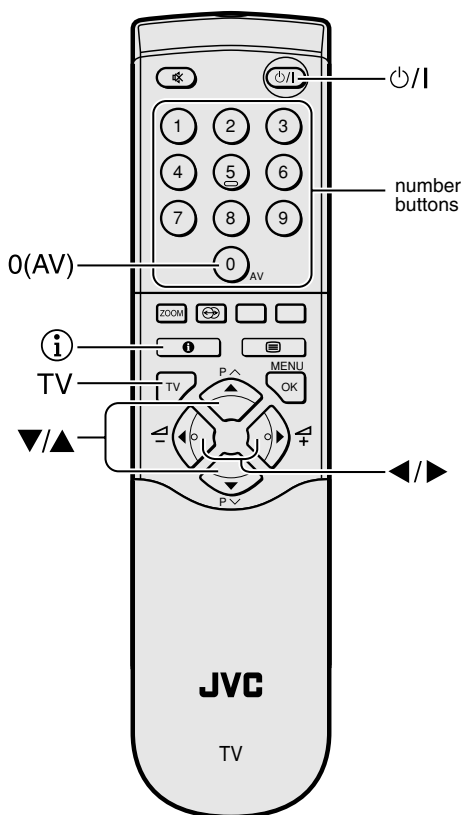

## 2 Press the ◀/▶ and ▼/▲ buttons to choose a programme number (PR). Then press the OK button

- For programme numbers (PR) where you have the CHILD LOCK function set, the **⏹** (CHILD LOCK) mark appears next to the programme number (PR) in the PR LIST.
- You cannot use the ▼/▲ buttons to choose a programme number (PR) which has the CHILD LOCK set.
- Even if you try to choose a programme number (PR) with the CHILD LOCK set, the **⏹** (CHILD LOCK) mark will appear, and you cannot watch the TV channel. To watch the TV channel, see “CHILD LOCK” on page 23.
- If you do not have a clear picture or no colour appears, change the colour system manually. See “COLOUR SYSTEM” on page 18.

## ■ Changing the volume

### Press the ◀/▶ buttons to change the volume.

The volume indicator appears, and the volume changes, as you press the -/+ buttons.

## ■ Watching images from external equipment

Choose the EXT terminal that the external equipment has been connected to.

### Use the 0 (AV) button:

Press the 0 (AV) button to choose an EXT terminal.

Pressing the 0 (AV) button changes the choice as follows:

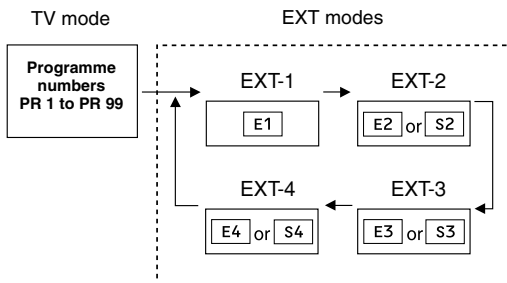

### Use the ▼/▲ buttons:

Press the ▼/▲ buttons to choose an EXT terminal

### Use the PR LIST:

#### 1 Press the **i** (information) button to display the PR LIST

#### 2 Press the ◀/▶ and ▼/▲ buttons to choose an EXT terminal. Then press the OK button

- The EXT terminals are listed after programme number PR 99.
- You can choose two types of video input signal: S-VIDEO (Y/C signal) and regular video (composite signal). For details, see “**S** (S-VIDEO input)” on page 21.
- If you do not have a clear picture or no colour appears, change the colour system manually. See “COLOUR SYSTEM” on page 18.
- If you choose an EXT terminal with no input signal, the EXT terminal number becomes fixed on the screen.
- This TV set can automatically change over the input according to a special signal from an external device. (The EXT-4 terminal does not support it.)

### To use the programme number PR 0 (AV):

When the TV and VCR are connected only by the aerial cable, choosing the programme number PR 0 (AV) allows you to view images from the VCR. Set the VCR RF channel to programme number PR 0 (AV) manually. For details, see “EDIT/MANUAL” on page 26.

Pressing the 0 (AV) button changes the choice as follows:

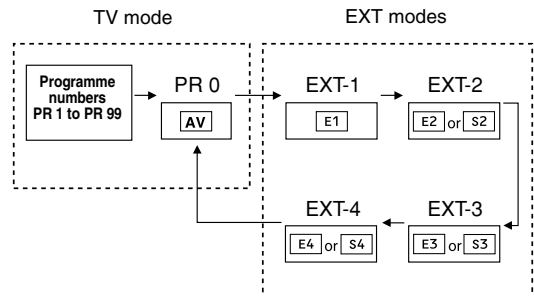

- The VCR sends its playback image along the aerial cable as an RF (radio frequency) signal.
- Also see your VCR instruction manual.

### To return to a TV channel:

Press the **TV** button, the ▼/▲ buttons or the number buttons.

## ■ Using the buttons on the TV

- 1** Press the **P**  $\nabla/\wedge$  buttons to turn the TV on from standby mode
- 2** Press the **P**  $\nabla/\wedge$  buttons to choose a programme number (**PR**) or an **EXT** terminal
- 3** Press the  $\triangleleft$  (volume) button and the  $-/+$  buttons to change the volume
  - 1** Press the  $\triangleleft$  (volume) button  
The volume level indicator appears
  - 2** Press the  $-/+$  buttons while the volume level indicator is on screen

Behind the Cover

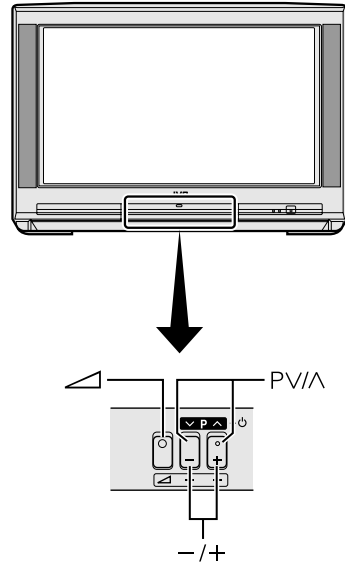

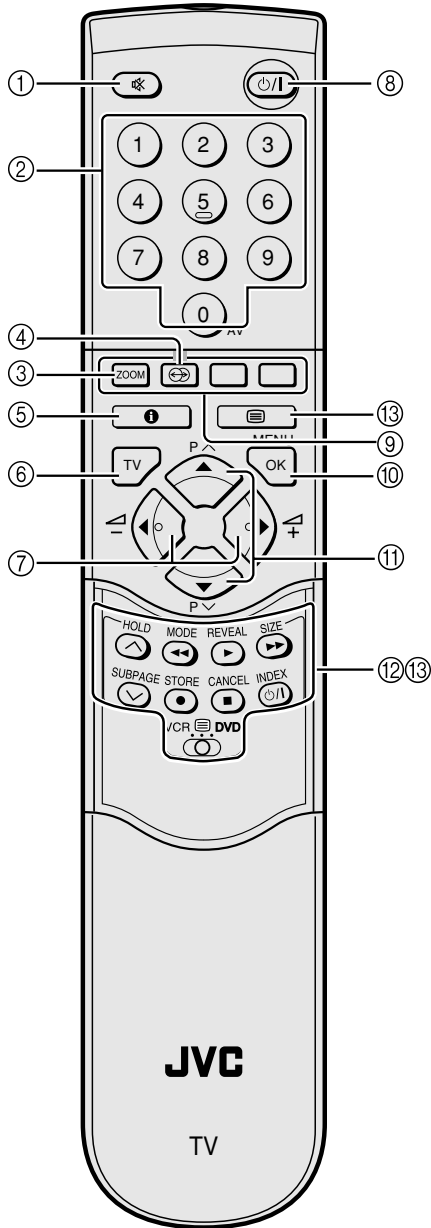

# Remote control buttons and functions



## ① Muting button

You can turn the sound off instantly.

Press the  (muting) button to turn off the sound. Pressing the  (muting) button again restores the previous volume level

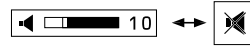

## ② Number buttons

You can choose a programme number (PR) by entering the programme number

Example

- PR12 → press 1 and 2.
- PR6 → press 6.

You can also press the 0 (AV) button repeatedly to choose an EXT terminal.

## ③ ZOOM button

You can change the screen size by changing the picture aspect ratio. The normal aspect ratio is 4:3 (width:height). Choose the ideal one from the following ZOOM modes.

### AUTO (WSS):

For any picture format except normal picture (4:3 aspect ratio), the picture will be automatically displayed in the ideal screen size.

For normal picture (4:3 Aspect Ratio), you can choose a ZOOM mode from the 4:3 AUTO ASPECT menu. For details, see "4:3 AUTO ASPECT" on page 19.

- AUTO may not work properly with poor signal quality. In this case, choose the best ZOOM mode manually.
- This TV supports WSS (wide-screen signals). When broadcasts with WSS are received with the ZOOM mode set at AUTO (WSS), the most suitable ZOOM mode is automatically chosen according to the WSS received.

### REGULAR:

Use to view a normal picture (4:3 aspect ratio) as this is its original shape.

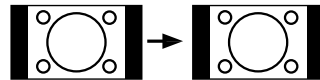

### PANORAMIC:

This stretches the left and right sides of a normal picture (4:3 aspect ratio) to fill the screen, without making the picture appear unnatural.

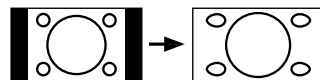

- The top and bottom of the picture are slightly cut off.



### 14:9 ZOOM:

This zooms up the wide picture (14:9 aspect ratio) to the upper and lower limits of the screen.



### 16:9 ZOOM:

This zooms up the wide picture (16:9 aspect ratio) to the full screen.



### 16:9 ZOOM SUBTITLE:

This zooms up the wide picture (16:9 aspect ratio) with subtitles to the full screen.



### FULL:

This uniformly stretches the left and right sides of a normal picture (4:3 aspect ratio) to fill the wide TV screen.

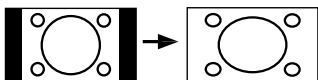

- For 16:9 aspect ratio pictures that have been squeezed into a normal picture (4:3 aspect ratio), use the FULL mode to restore the picture to its original shape.

## Choose the ZOOM mode

- 1 Press the ZOOM button to display the ZOOM menu

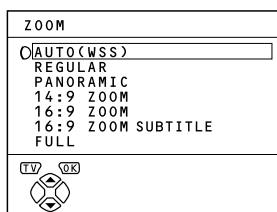

- 2 Press the ▼/▲ buttons to choose a ZOOM mode. Then press the OK button

The picture expands and the chosen ZOOM mode is displayed in about 5 seconds.

- The ZOOM mode may be automatically changed by the control signal from an external device. When you want to return to the previous ZOOM mode, choose the ZOOM mode again.

## Adjusting the visible area of the picture

If subtitles or the top (or bottom) of the picture are cut off, you can adjust the visible area of the picture manually.

- 1 Press the ZOOM button

The ZOOM menu appears.

- 2 Press the OK button to display the ZOOM mode indicator

The indicator appears.

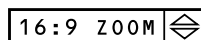

- 3 While it is displayed, press the ▼/▲ buttons to change the height of the picture

- You cannot adjust the visible area in REGULAR or FULL mode.

## ④ HYPER SOUND button

You can enjoy sounds with a wider ambience.

Press the ⊕⊖ (HYPER SOUND) button to turn the HYPER SOUND function on or off

- The HYPER SOUND function does not work properly with mono sound.
- The HYPER SOUND function can be also turned on or off by using the SOUND SETTING menu. For details, see "HYPER SOUND" on page 20.

## ⑤ Information button

You can display the PR LIST or the current time on the screen.

### Press the **i** (information) button

Pressing the **i** (information) button changes the display as follows:

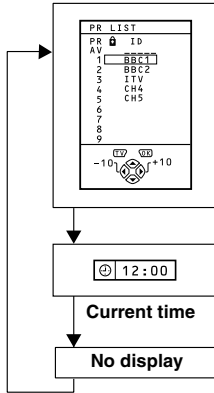

- You can choose programme numbers (PR) or EXT terminals with the PR LIST. For details, see "Use the PR LIST:" on page 8.
- This TV uses teletext data to set the time. If the TV has not received a TV channel that has teletext programmes since it was turned on, the time display is blank. To see the time, choose a TV channel that has teletext programmes. The time will still be displayed as long as you do not turn off the TV, even if you choose other TV channels.
- When watching videos, the incorrect time is sometimes displayed.
- The **i** (information) button will also operate menus. For details, see "Using the TV's menus" on page 16.

## ⑥ TV button

You can return to a TV channel instantly.

### Press the **TV** button.

*The TV returns to the TV mode and a TV channel appears.*

- The **TV** button will also operate menus. For details, see "Using the TV's menus" on page 16.

## ⑦ ◀/▶ Buttons

You can adjust the volume.

### Press the **◀/▶** buttons to adjust the sound.

- The **◀/▶** buttons will also operate menus. For details, see "Using the TV's menus" on page 16.

## ⑧ Standby button

Press the **⏻/⏻** (standby) button to turn the TV on or off.

*When the TV is turned on, the power lamp changes from red to green.*

## ⑨ Colour buttons

The colour buttons are used for the teletext operations or the menu operations. For details, see "⑬ Teletext control buttons and VCR **⏻** DVD switch" on page 14 or "Using the TV's menus" on page 16.

## ⑩ OK button

The **OK** button is used to operate menus. For details, see "Using the TV's menus" on page 16.

## ⑪ ▼/▲ Buttons

You can choose a programme number (PR) or an EXT terminal.

### Press the **▼/▲** buttons to choose a Programme number (PR) or an EXT terminal.

The **▼/▲** buttons will also operate menus. For details, see "Using the TV's menus" on page 16.

## ⑫ VCR/DVD control buttons and VCR **⏻** DVD switch

These buttons will operate a JVC brand VCR or DVD player. Pressing a button that looks the same as the device's original remote control button has the same effect as the original remote control.

### 1 Set the VCR **⏻** DVD switch to the VCR or DVD position.

#### VCR:

When you are using a VCR, set the switch to the VCR position.

#### DVD:

When you are using a DVD player, set the switch to the DVD position.

### 2 Press the VCR/DVD control button to control your VCR or DVD player

- If your device is not made by JVC, these buttons will not work.
- Even if your device is made by JVC, some of these buttons may not work, depending on the device you are using.
- You can use the **▼/▲** buttons to choose a TV channel the VCR will receive, or choose the chapter the DVD player plays back.
- Some models of DVD player use the **▼/▲** buttons for both operating the fast forward/backward functions and for choosing the chapter. In this case, the **◀/▶** buttons do not work.

## 13 Teletext control buttons and VCR DVD switch

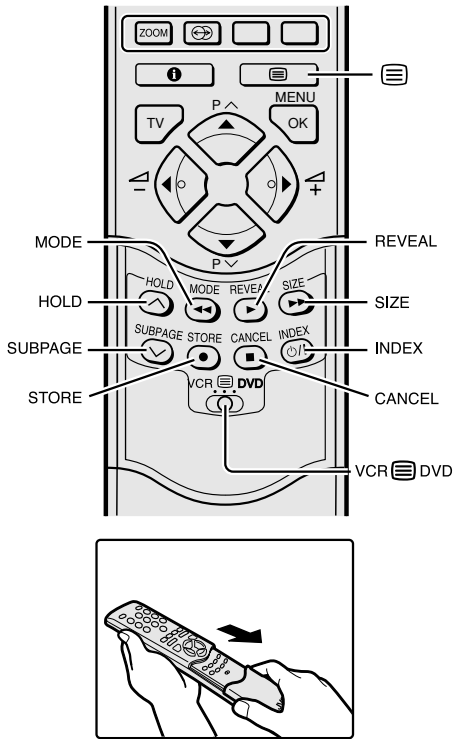



### Basic operation

You can view two types of teletext broadcasts on the TV: FLOF (Fasttext) and WST (World Standard Text).



- 1 Choose a TV channel with a teletext broadcast
- 2 Set the VCR DVD switch to the  (Text) position

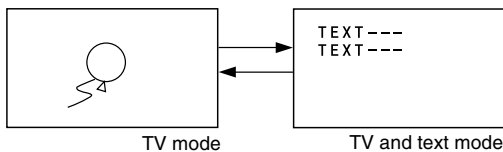

- 3 Press the  (Text) button to display the teletext

Pressing the  (Text) button changes the mode as follows:



- 4 Choose a teletext page by pressing the / buttons, number buttons or colour buttons

#### To return to the TV mode:

Press the **TV** button or  (Text) button.

- If you have trouble receiving teletext broadcasts, contact your local dealer or the teletext station.
- The ZOOM function will not work in the text mode or TV and text mode.
- You cannot operate menus when viewing a teletext programme.

### Using the List Mode

You can store the numbers of your favourite teletext pages in memory and call them up quickly using the colour buttons.

#### To store the page numbers:

- 1 Press the **MODE** button to go into the List mode

The page numbers you have stored are displayed at the bottom of the screen.

- 2 Press a colour button to choose a position. Then press the number buttons to enter the page number

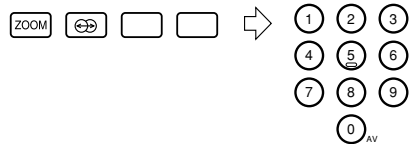

- 3 Press and hold down the **STORE** button

The four page numbers blink white to show that they are stored in memory.

#### To call up a stored page:

- 1 Press the **MODE** button to enter the List mode
- 2 Press a colour button having a stored page



#### To leave the List mode:

Press the **MODE** button again.

## Hold

You can hold a teletext page on the screen for as long as you want, even while several other teletext pages are being received.

### Press the HOLD button

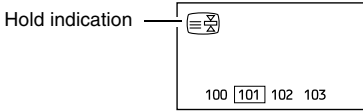

### To cancel the Hold function:

Press the **HOLD** button again.

## Sub-page

Some teletext pages include sub-pages that are automatically displayed.

You can hold any sub-page, or view it at any time.

- 1 Press the **SUBPAGE** button to operate the sub-page function
- 2 Press the number buttons to enter a sub-page number

#### Example

- 3rd sub-page → press 0, 0, 0, and 3.

### To cancel the sub-page function:

Press the **SUBPAGE** button again.

- You can also choose a sub-page by pressing the red or green button.

## Reveal

Some teletext pages include hidden text (such as the answers to a quiz).

You can display the hidden text.

### Each time you press the REVEAL button, text is hidden or revealed

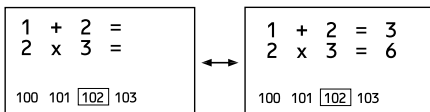

## Size

You can double the height of the teletext display.

### Press the SIZE button

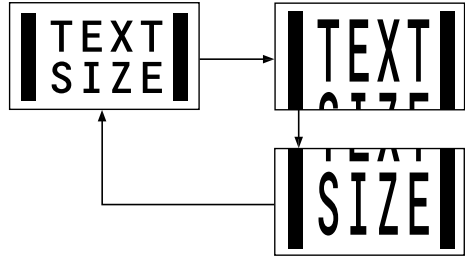

## Index

You can return to the index page instantly.

### Press the INDEX button

#### *FLOF (Fastext)/WST (World Standard Text):*

Returns to page 100 or a previously specified page.

#### *List mode:*

Returns to the page number displayed in the lower left area of the screen.

## Cancel

You can search for a teletext page while watching TV.

- 1 Press the number button to enter a page number, or press a colour button

The TV searches for a teletext page.

- 2 Press the **CANCEL** button

The TV programme appears. When the TV finds the teletext page, its page number appears in the upper left of the screen.

- 3 Press the **CANCEL** button to return to a teletext page when the page number is on the screen

#### Note:

- The TV mode cannot be resumed by pressing the **CANCEL** button. To return to the TV mode press **TV**.

# Using the TV's menus

---

This TV has a number of functions you can operate using menus. To use all your TV's functions fully, you need to understand how to use the basic menus.

## 1 Press the OK button to display the MENU (main menu)

The MENU (main menu) appears. In it, the titles of the menus are displayed.

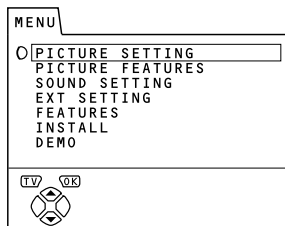

## 2 Press the ▼/▲ buttons to choose a menu title, and press the OK button

The menu appears.

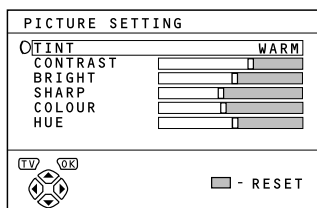

## 3 Follow the menus according to the function you want to use

- For more details, see the descriptions of each menu and its functions on the following pages.
- The display appearing at the bottom of a menu shows you a button on the remote control that you can use when you operate a chosen function.

## 4 Press the OK button to complete the setting

The menu disappears.

### To return to the previous menu:

Press the **i** (information) button.

### To exit a menu instantly:

Press the **TV** button.

- When watching the television with the NTSC system, the menus are displayed at about half of their normal vertical size.

# Picture setting

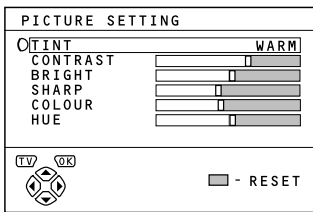

To display the PICTURE SETTING menu:

- 1 Press the **OK** button to display the MENU (main menu)
- 2 Press the **▼/▲** buttons to choose PICTURE SETTING, and press the **OK** button

## ■ TINT

You can select one of three TINT modes (three kinds of picture settings) to adjust the picture settings automatically.

- 1 Press the **▼/▲** buttons to choose TINT
- 2 Press the **◀/▶** buttons to choose a mode

### **COOL:**

A cool white colour base with a boost in the colour and contrast levels that creates a more vivid picture.

### **WARM:**

A warm orange/red colour base that creates the appropriate colour and contrast levels for watching films.

### **NORMAL:**

A normal white colour base with normal colour and contrast levels.

- 3 Press the **OK** button to complete the setting

*The menu disappears.*

## ■ Picture adjustment

You can change the picture settings of each TINT mode as you like.

The picture settings changed are stored in the TINT mode.

- 1 Press the **▼/▲** buttons to choose an item
- 2 Press the **◀/▶** buttons to change the setting

◀	Item	▶
Lower	<b>CONTRAST</b> (picture contrast)	Higher
Darker	<b>BRIGHT</b> (picture brightness)	Brighter
Softer	<b>SHARP</b> (picture sharpness)	Sharper
Lighter	<b>COLOUR</b> (picture colour)	Deeper
Reddish	<b>HUE</b> (picture hue)	Greenish

- You can change the HUE setting (picture hue) only when the colour system is NTSC 3.58 or NTSC 4.43. (See "Specifications" on the back cover.)

### To return to the default settings in each TINT mode:

Press the blue button.

*This returns the picture settings in the TINT mode you have chosen to the default settings, and stores them in the TINT mode.*

- 3 Press the **OK** button to complete the settings

*The menu disappears.*

# Picture features

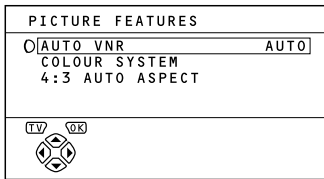

To display the PICTURE FEATURES menu:

- 1 Press the **OK** button to display MENU (main menu)
- 2 Press the **▼/▲** buttons to choose PICTURE FEATURES, and press the **OK** button

## ■ AUTO VNR

VNR Stands for “video noise reduction”.

The AUTO VNR function reduces any “noise” (interference or snowing) in the current picture. The function also adjusts the optimum Sharpness of the picture (SHARP).

- 1 Press the **▼/▲** buttons to choose **AUTO VNR**
- 2 Press the **◀/▶** buttons to choose **AUTO**

### **MIN:**

The AUTO VNR function is cancelled. When you set the mode to AUTO but feel that the sharpness of the original picture has not been reproduced fully, change the mode to MIN. However, any noise remaining in the original picture may be emphasized.

### **MAX:**

This mode always reduces any noise as much as possible, irrespective of state of the picture. When you set the mode to AUTO but still notice some noise, change the mode to MAX. However, this may reduce the sharpness of the picture.

- 3 Press the **OK** button to complete the setting

*The menu disappears.*

## ■ COLOUR SYSTEM

The colour system is chosen automatically. However, if the picture is not clear or no colour appears, choose the colour system manually.

- 1 Press the **▼/▲** buttons to choose **COLOUR SYSTEM**. Then press the **OK** button

The sub-menu of the COLOUR SYSTEM function appears.

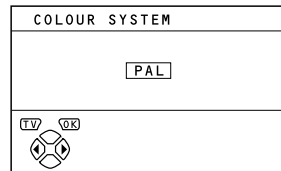

- 2 Press the **◀/▶** buttons to choose the appropriate colour system

### **PAL:**

PAL system

### **NTSC 3.58:**

NTSC 3.58 MHz system

### **NTSC 4.43:**

NTSC 4.43 MHz system

### **AUTO:**

This function detects a colour system from the input signal. You can only use this when you are viewing a picture from programme number PR 0 (AV), or an EXT terminal.

- 3 Press the **OK** button to complete the setting

*The menu disappears.*

- The AUTO function may not work properly if you have poor signal quality. If the picture is abnormal in the AUTO function, choose another colour system manually.
- You cannot choose NTSC 3.58 or NTSC 4.43 for programme numbers PR 0 (AV) to PR 99.

## ■ 4:3 AUTO ASPECT

You can choose one of three ZOOM modes, REGULAR, PANORAMIC or 14:9 ZOOM, as the ZOOM mode for the normal picture (4:3 aspect ratio).

### 1 Press the ▼/▲ buttons to choose 4:3 AUTO ASPECT. Then press the OK button

The sub-menu of the 4:3 AUTO ASPECT function appears.

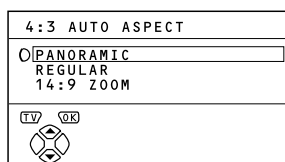

### 2 Press the ▼/▲ buttons to choose a ZOOM mode

### 3 Press the OK button to complete the setting

The menu disappears.



# Sound setting

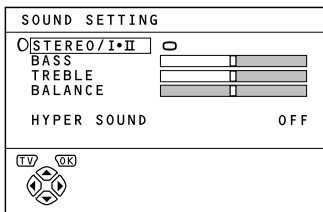

To display the SOUND SETTING menu:

- 1 Press the **OK** button to display the MENU (main menu)
- 2 Press the **▼/▲** buttons to choose **SOUND SETTING**. Then press the **OK** button

## ■ STEREO / I • II

When you are viewing a bilingual broadcast programme, you can choose the sound from Bilingual I (Sub I) or Bilingual II (Sub II). If you have poor reception on a stereo broadcast, you can change from stereo to mono sound so that you can hear the broadcast more clearly and easily.

- 1 Press the **▼/▲** buttons to choose **STEREO / I • II**
- 2 Press the **◀/▶** buttons to choose a sound mode

∞ : Stereo sound  
○ : mono sound  
I : Bilingual I (sub I)  
II : Bilingual II (sub II)

- 3 Press the **OK** button to complete the setting

*The menu disappears.*

- The sound mode you can choose differs depending on the TV programme.
- This function does not work in the EXT modes. And this function does not appear in the SOUND SETTING menu.

## ■ Sound adjustment

You can adjust the sound to your liking.

- 1 Press the **▼/▲** buttons to choose an item
- 2 Press the **◀/▶** buttons to adjust it

◀	Item	▶
Weaker	<b>BASS</b>	Stronger
Weaker	<b>TREBLE</b>	Stronger
Left	<b>BALANCE</b>	Right

- 3 Press the **OK** button to complete the setting

*The menu disappears.*

## ■ HYPER SOUND

You can enjoy sounds with a wider ambience.

- 1 Press the **▼/▲** buttons to choose **HYPER SOUND**
- 2 Press the **◀/▶** buttons to choose **ON**  
To cancel the HYPER SOUND function:  
Press the **◀/▶** buttons to choose **OFF**.
- 3 Press the **OK** button to complete the setting

*The menu disappears*

- The HYPER SOUND function does not work properly with mono sound.
- You can turn the HYPER SOUND function on or off with a single press. For details, see “④ HYPER SOUND button” on page 12.

# EXT SETTING

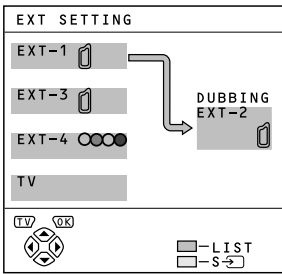

To display the EXT SETTING menu:

- 1 Press the **OK** button to display the **MENU** (main menu)
- 2 Press the **▼/▲** buttons to choose **EXT SETTING**. Then press the **OK** button

## ■ S-V (S-VIDEO input)

You can connect a device (such as an S-VHS VCR) to enjoy the high-quality picture of the S-VIDEO signal (Y/C signal).

### Preparation:

- First read the device's instruction manual and "Further preparation" on page 31 to connect the device to the TV properly. Second, follow the device's instruction manual to set the device so that it sends an S-VIDEO signal (Y/C signal) to the TV.
- Do not set S-V (S-VIDEO input) to an EXT terminal connected to a device which cannot output an S-VIDEO (Y/C signal). If it is set wrongly, a picture cannot appear.

- 1 Press the **▼/▲** buttons or **◀/▶** buttons to choose an **EXT terminal**

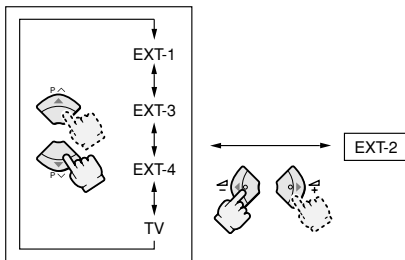

- 2 Press the **yellow** button and set the **S-V** (S-VIDEO input)

An **S-V** (S-VIDEO input) mark is displayed. You can view an S-VIDEO signal (Y/C signal) instead of the regular video signal (composite signal).

### To cancel the S-V (S-VIDEO input) setting:

Press the **yellow** button and turn off the **S-V** (S-VIDEO input) mark.

The regular video signal (composite signal) pictures are resumed.

- 3 Press the **OK** button to complete the setting

The menu disappears.

- The EXT-1 terminal does not support S-VIDEO signal (Y/C signal) and you cannot set S-V (S-VIDEO input) in the EXT-1 terminal.
- Setting S-V (S-VIDEO input) changes the head character from "E" to "S". When an EXT terminal receives a normal video signal, "E1", "E2", "E3" or "E4" appears on the display. This changes to "S2", "S3" or "S4" when it receives an S-VIDEO signal.
- Even a device which can output an S-VIDEO signal (Y/C signal) may output a regular video signal (composite signal) depending on the device setting. If a picture cannot appear because the S-V (S-VIDEO input) setting has been made, read the device instruction manual carefully again to check for the device settings.

## ■ LIST

You can store a name for each of the devices connected to each EXT terminal. Giving a name to an EXT terminal makes the EXT terminal number appear on the screen, together with its name.

- 1 Press the **▼/▲** buttons or **◀/▶** buttons to choose an **EXT terminal**

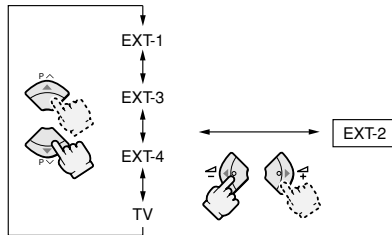

- 2 Press the **blue** button to display the name list (LIST)

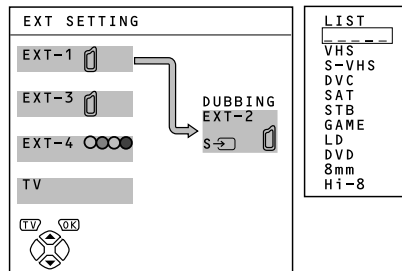

- 3 Press the **▼/▲** buttons to choose a name. Then press the **OK** button

The **LIST** disappears and the name is assigned to the **EXT terminal**.

**To erase a name assigned to the EXT terminal:** Choose a blank space.

- 4 Press the **OK** button to complete the setting

The menu disappears.

- You cannot choose an EXT terminal name that is not on the name list (ID LIST).

## ■ DUBBING

You can choose a signal source to be output from the EXT-2 terminal.

You can do this with the output signal of the device connected to another EXT terminal, or the picture and sound from a TV channel you are currently viewing.

- 1 Press the ◀/▶ buttons to choose the EXT-2 terminal.
- 2 Press the ▼/▲ buttons to choose another EXT terminal or TV.

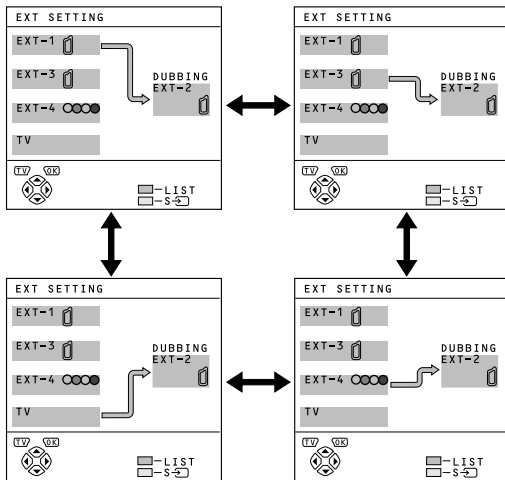

The arrow in the menu represents a signal flow. The left side of the arrow shows a signal source output from the EXT-2 terminal.

### **EXT-1/EXT-3/EXT-4:**

The output signal of the device connected to an EXT terminal passes through the TV and is output from the EXT-2 terminal.

### **TV:**

The picture and sound of the TV channel you are currently viewing are output from the EXT-2 terminal.

- 3 Press the OK button to complete the setting.

*The menu disappears.*

- During dubbing, you cannot turn off the TV. Turning off the TV also turns off the output from the EXT-2 terminal.
- When you choose an EXT terminal as an output, you can view a TV programme or a picture from the other EXT terminal while dubbing the picture from a device connected to the EXT terminal onto a VCR connected to the EXT-2 terminal.  
The RGB signals from TV games cannot be output. Teletext programmes cannot be output.

# FEATURES

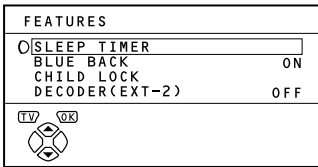

To display the FEATURES menu:

- 1 Press the **OK** button to display the MENU (main menu)
- 2 Press the **▼/▲** buttons to choose FEATURES. Then press the **OK** button

## ■ SLEEP TIMER

You can set the TV to automatically turn off after a set time.

- 1 Press the **▼/▲** buttons to choose **SLEEP TIMER**. Then press the **OK** button

A sub-menu of the SLEEP TIMER function appears.

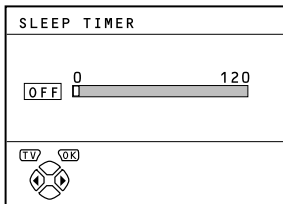

- 2 Press the **◀/▶** buttons to set the period of time

You can set the time for up to 120 minutes (2 hours) in 10 minute steps.

**To cancel the SLEEP TIMER function:**

Press the **◀** button to set the period of time to "OFF."

- 3 Press the **OK** button to complete the setting

*The menu disappears.*

- One minute before the SLEEP TIMER function turns off the TV, "GOOD NIGHT!" appears.
- The SLEEP TIMER function cannot be used to turn off the TV's main power.
- When the SLEEP TIMER function is on, you can display the sub-menu of the SLEEP TIMER function again to confirm or change the remaining period of time of the SLEEP TIMER function. Press the **OK** button to leave the menu after confirming or changing the remaining time.

## ■ BLUE BACK

You can set the TV to automatically change to a blue screen and mute the sound if the signal is weak or absent, or when there is no input from an external device.

- 1 Press the **▼/▲** buttons to choose **BLUE BACK**
- 2 Press the **◀/▶** buttons to choose **ON**

**To cancel the BLUE BACK function:**

Press the **◀/▶** buttons to choose OFF.

- 3 Press the **OK** button to complete the setting

*The menu disappears.*

## ■ CHILD LOCK

When there is a TV channel you do not want your children to watch, you can use the CHILD LOCK function to lock out the TV channel. Even when a child chooses a programme number (PR) for a locked TV channel the screen will change to blue and display **Ⓐ** (CHILD LOCK) so the TV channel cannot be viewed. Unless you enter a pre-set ID number by a special operation, the lock cannot be released and the child cannot view the TV channel.

### To set the CHILD LOCK function

- 1 Press the **▼/▲** buttons to choose **CHILD LOCK**. Then press the **0 (AV)** button

*"SET ID NO." (ID number setting screen) appears.*

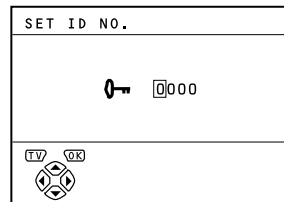

- 2 To set the ID number you want

- 1 Press the **▼/▲** buttons to choose a number
- 2 Press the **◀/▶** buttons to move the cursor

- 3 Press the **OK** button

*The sub-menu of CHILD LOCK appears.*

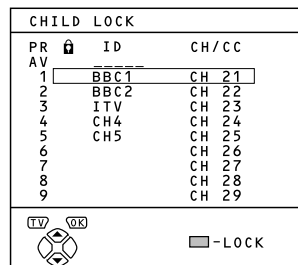

- 4 Press the **▼/▲** buttons to choose a TV channel

Every time you press the **▼/▲** buttons, the programme number (PR) changes, and the picture of the TV channel registered in the programme number (PR) is displayed on the screen.

**5 Press the blue button and set the CHILD LOCK function**

🔒 (CHILD LOCK) appears and the TV channel is locked.

**To reset the CHILD LOCK function:**

Press the blue button again.

🔒 (CHILD LOCK) disappears.

**6 Press the OK button to complete the setting**

The menu disappears.

- To disable easy resetting of the CHILD LOCK function, the menu disappears if you choose the CHILD LOCK function and press the **OK** button.

**To view a locked TV channel**

**1 Choose a programme number (PR) for a locked TV channel, by using the number buttons or PR LIST**

The screen changes to blue and the 🔒 (CHILD LOCK) appears. You cannot view the TV channel.

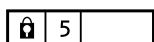

**2 Press the ⓘ (information) button to display "ID NO." (ID NO. input screen)**

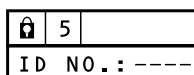

**3 Press the number buttons to enter the ID number**

The lock is temporarily released so you can view the TV channel.

**If you have forgotten the ID number:**

Perform step 1 of "To set the CHILD LOCK function". After confirming the ID number, press the **TV** button to exit the menu.

- Even if you reset the lock temporarily, it does not mean that the CHILD LOCK function set for the TV channel is cancelled. The next time anyone tries to view the TV channel, it will be locked again.
- When you want to cancel the CHILD LOCK function, you must perform the operation "To set the CHILD LOCK function" again.
- To stop it being easy to choose the programme number (PR) of a locked TV channel, the programme number (PR) has been set so that it cannot be chosen by the ▼/▲ buttons or the buttons of the TV.
- To stop it being easy to reset the lock, "ID NO." (ID NO. input screen) is set so that it cannot appear unless you press the ⓘ (Information) button.

**■ DECODER (EXT-2)**

You can only use this function if you have a decoder connected to a T-V LINK compatible VCR, which in turn is connected to the EXT-2 terminal. To use this function, see "Using the DECODER (EXT-2) function" on page 30.

- If you have not connected a decoder with a T-V LINK compatible VCR to the EXT-2 terminal, setting this function to "ON" by mistake causes the picture/sound of a TV channel you are currently viewing to disappear.

# INSTALL

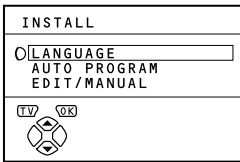

To display the INSTALL menu:

- 1 Press the **OK** button to display the MENU (main menu)
- 2 Press the **▼/▲** buttons to choose the INSTALL menu. Then press the **OK** button

## ■ LANGUAGE

You can choose the language you want to use for the on-screen display from the language list in the menu.

- 1 Press the **▼/▲** buttons to choose **LANGUAGE**. Then press the **OK** button

A sub-menu of the LANGUAGE function appears.



- 2 Press the **◀/▶** and **▼/▲** buttons to choose a language
- 3 Press the **OK** button to complete the setting

The menu disappears.

## ■ AUTO PROGRAM

You can automatically store the TV channels for which you have the best reception. Store them in the TV's programme numbers (PR) list by doing the following.

- 1 Press the **▼/▲** buttons to choose **AUTO PROGRAM**
- 2 Press the **OK** button to start the **AUTO PROGRAM** function

The AUTO PROGRAM menu appears and the TV channels you receive are automatically registered in the programme numbers (PR) list.

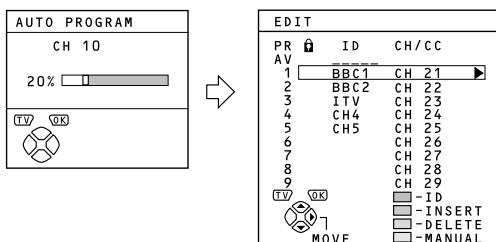

To cancel the **AUTO PROGRAM** function:

Press the **TV** button.

- 3 After the TV channels have been stored in the programme numbers (PR) list, the **EDIT** menu appears

You can now edit the programme numbers (PR) list using the **EDIT/MANUAL** function. For details, see "EDIT/MANUAL" on page 26.

**When not using the EDIT/MANUAL function:**

If you do not need to use the **EDIT/MANUAL** function, go to the next step.

- 4 Press the **OK** button to display the **T-V LINK** menu

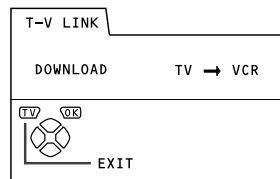

- 5 Operate the **T-V LINK** menu according to the type of video cassette recorder (VCR) you have connected to the **EXT-2** terminal

**If you do not have a T-V LINK compatible VCR connected:**

Press the **TV** button to leave the T-V LINK menu.

The T-V LINK menu disappears, and all the settings are completed.

**If you have a T-V LINK compatible VCR connected:**

See "Downloading data to a VCR" on page 30 to transmit the programme number (PR) data to the VCR.

- If a TV channel you want to view is not set to a programme number (PR), set it manually using the **MANUAL** function. For details, see "EDIT/MANUAL" on page 26.
- The **AUTO PROGRAM** function does not set the programme number PR 0 (AV) for your video cassette recorder. You will need to set this using the manual function.
- In some areas you may get TV reception from more than one transmitter, for example different ITV regions. In this case each TV channel could be set twice. If this happens, the first set of channels will have the stronger signal. If you want to delete the second set of channels, you will have to do it manually (see page 28).

## EDIT/MANUAL

The EDIT/MANUAL functions are divided into two types:

- editing the current programme numbers (PR) (EDIT functions); and
- manually storing a TV channel you want to view as a programme number (PR) (MANUAL function).

Here are the details about these functions:

### MOVE:

This function changes the programme number (PR) of a TV channel.

### ID:

This function registers a channel name (ID) to a TV channel.

### INSERT:

This function adds a new TV channel in the current programme numbers (PR) list by using the CH/CC number.

### DELETE:

This function deletes a TV channel you do not want to list.

### MANUAL:

This function manually stores a new TV channel in a programme number (PR).

- For programme number PR 0, "AV" appears in the programme numbers (PR) list.
- An EXT terminal number does not appear in the programme numbers (PR) list.
- The CH/CC number is a number unique to the TV and corresponds to the channel number of a TV channel. For the relationship between a channel number and a CH/CC number, see "CH/CC NUMBER" on page 28.
- You cannot use the INSERT function if you do not know the channel number of a TV channel. Use the MANUAL function to register a TV channel in the programme number (PR) list.

### Caution:

- Using the MOVE, DELETE or INSERT functions rewrites the current programme numbers (PR) list. Therefore, the programme numbers (PR) of some of the TV channels will change.
- Using the MANUAL function for a TV channel for which the CHILD LOCK function has been set cancels the CHILD LOCK function for that channel.
- Using the MANUAL function for a TV channel for which the DECODER (EXT-2) function has been set to ON returns the setting of the DECODER (EXT-2) function for that channel to OFF.
- When a TV channel has already been registered in PR 99, using the INSERT function deletes that TV channel.

- 1 Press the **▼/▲** buttons to choose EDIT/MANUAL. Then press the **OK** button

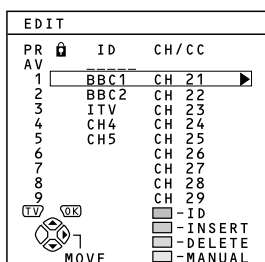

- 2 Follow the options for the function you want to use

- 3 Press the **OK** button to complete the settings

The T-V LINK menu appears.

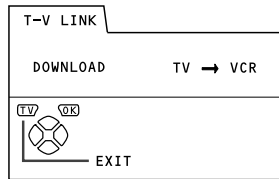

- 4 Follow the T-V LINK menu according to the type of VCR you have connected to the EXT-2 terminal

**If you do not have a T-V LINK compatible VCR connected:**

Press the **TV** button to leave the T-V LINK menu.

The T-V LINK menu disappears and all the settings are completed.

**If you have a T-V LINK compatible VCR connected:**

Follow the operating procedure "Downloading data to a VCR" on page 30 to transmit the programme number (PR) data to the VCR.

## MOVE

- 1 Press the **▼/▲** buttons to choose a TV channel

Every time you press the **▼/▲** buttons, the programme number (PR) changes, and the picture of the TV channel stored in the programme number (PR) appears on the screen.

- 2 Press the **▶** button to start the MOVE function

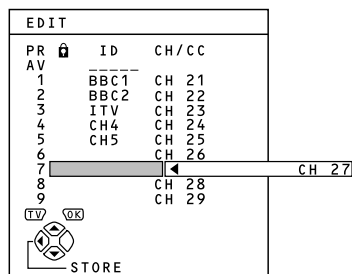

- 3 Press the **▼/▲** buttons to choose a new programme number (PR)

**To cancel the MOVE function:**

Press the **i** (information) button.

- 4 Press the **◀** button to change the programme number (PR) of a TV channel to a new programme number (PR)

## ID

### 1 Press the ▼/▲ buttons to choose a TV channel

Every time you press the ▼/▲ buttons, the programme number (PR) changes, and the picture of the TV channel stored in the programme number (PR) appears on the screen.

### 2 Press the red button to start the ID function

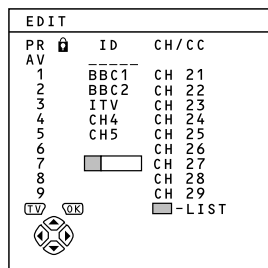

### 3 Press the ▼/▲ buttons to choose the first character of a channel name (ID) you want to give the TV channel

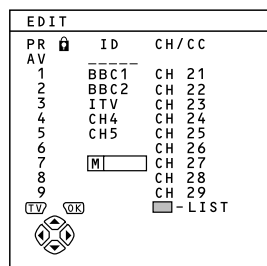

### 4 Press the blue button to display the ID LIST (channel name list)

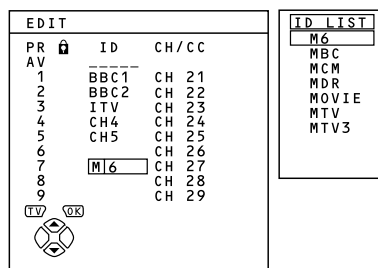

### 5 Press the ▼/▲ buttons to choose the channel name (ID)

**To cancel the ID function:**

Press the ⓘ (Information) button.

### 6 Press the OK button to give a channel name (ID) to a TV channel

- You can give your own unique channel name (ID) to the TV channel. When you have finished step 3, do not go to step 4. Press the ◀/▶ buttons to move the cursor, and press the ▼/▲ buttons to choose each character of the channel name (ID). Then press the OK button to register the channel name (ID) to the TV channel.

## INSERT

**Preparation:**

- You need to find the CH/CC number for the TV channel. Find the CH/CC number from the “CH/CC NUMBER” table on page 28 based on the channel number of the TV channel.

### 1 Press the ▼/▲ buttons to choose a Programme number (PR) for which you will register a new TV channel

### 2 Press the green button and start the INSERT function

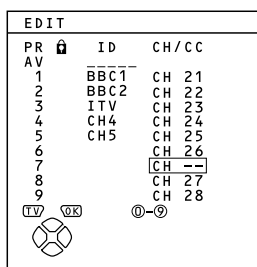

**To cancel the INSERT function:**

Press the ⓘ (Information) button.

### 3 For UK model (AV28CT1EK):

Press the number buttons to enter the remaining CH number.

- You cannot enter CC numbers.

**For Ireland model (AV28CT1EI):**

Press the ▼/▲ buttons to choose “CH” or “CC”, then enter the remaining CH or CC number.

*The TV shifts to registration mode.*

When the registration is completed, the picture of the TV channel appears on the screen.

- The CH/CC number is a number given to each broadcast frequency that carries a TV channel. If the TV cannot detect the TV channel corresponding to the broadcast frequency indicated by the CH/CC number, a “no-signal” picture appears.



## DELETE

### 1 Press the ▼/▲ buttons to choose a TV channel

Every time you press the ▼/▲ buttons, the programme number (PR) changes over, and the picture of the TV channel stored in the programme number list (PR) appears on the screen.

### 2 Press the yellow button to delete the TV channel

The TV channel is deleted from the programme numbers (PR) list.

## MANUAL

### 1 Press the ▼/▲ buttons to choose a programme number (PR) for a new TV channel

### 2 Press the blue button to activate the MANUAL function

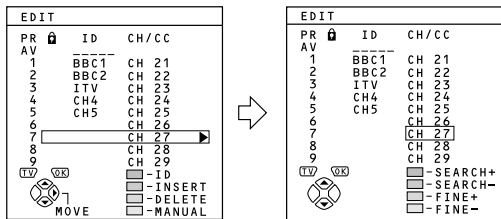

#### To cancel the MANUAL function:

Press the ⓘ (Information) button.

### 3 Press the green or red button to search for a TV channel

Scanning stops when the TV finds a TV channel. Then the TV channel is displayed.

### 4 Press the green or red button repeatedly until the TV channel you want appears

#### If the TV channel reception is poor:

Press the blue or yellow button to fine-tune the TV channel.

### 5 Press the OK button and register the TV channel to a programme number (PR)

The normal EDIT menu appears.

## CH/CC NUMBER

- When you want to use the INSERT function on page 27, find the CH/CC number corresponding to the channel number of the TV channel from this table. If you want to know a particular TV channel's channel menu, look in TV listings magazines or contact the broadcaster.
- The UK model (AV28CT1EK) cannot receive the CC number channels or the channels from CH 02 to CH 12.

CH	Channel	CH	Channel
CH 02	E2, IR A	CH 40	E40
CH 03	E3, IR B, ITALY A	CH 41	E41
CH 04	E4, IR C, ITALY B	CH 42	E42
CH 05	E5, IR D, ITALY D	CH 43	E43
CH 06	E6, IR E, ITALY E	CH 44	E44
CH 07	E7, IR F, ITALY F	CH 45	E45
CH 08	E8, IR G	CH 46	E46
CH 09	E9, ITALY G	CH 47	E47
CH 10	E10, IR H, ITALY H	CH 48	E48
CH 11	E11, IR J, ITALY H+1	CH 49	E49
CH 12	E12, ITALY H+2	CH 50	E50
CH 21	E21	CH 51	E51
CH 22	E22	CH 52	E52
CH 23	E23	CH 53	E53
CH 24	E24	CH 54	E54
CH 25	E25	CH 55	E55
CH 26	E26	CH 56	E56
CH 27	E27	CH 57	E57
CH 28	E28	CH 58	E58
CH 29	E29	CH 59	E59
CH 30	E30	CH 60	E60
CH 31	E31	CH 61	E61
CH 32	E32	CH 62	E62
CH 33	E33	CH 63	E63
CH 34	E34	CH 64	E64
CH 35	E35	CH 65	E65
CH 36	E36	CH 66	E66
CH 37	E37	CH 67	E67
CH 38	E38	CH 68	E68
CH 39	E39	CH 69	E69

CC	Channel	CC	Channel
CC 01	S1	CC 31	S31
CC 02	S2	CC 32	S32
CC 03	S3	CC 33	S33
CC 04	S4	CC 34	S34
CC 05	S5	CC 35	S35
CC 06	S6	CC 36	S36
CC 07	S7	CC 37	S37
CC 08	S8	CC 38	S38
CC 09	S9	CC 39	S39
CC 10	S10	CC 40	S40
CC 11	S11	CC 41	S41
CC 12	S12	CC 75	X
CC 13	S13	CC 76	Y
CC 14	S14	CC 77	Z, ITALY C
CC 15	S15	CC 78	Z+1
CC 16	S16	CC 79	Z+2
CC 17	S17		
CC 18	S18		
CC 19	S19		
CC 20	S20		
CC 21	S21		
CC 22	S22		
CC 23	S23		
CC 24	S24		
CC 25	S25		
CC 26	S26		
CC 27	S27		
CC 28	S28		
CC 29	S29		
CC 30	S30		

# DEMO

---

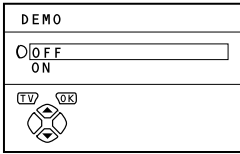

To display the DEMO menu:

- 1 Press the **OK** button to display the **MENU** (main menu)
- 2 Press the **▼/▲** buttons to choose **DEMO**. Then press the **OK** button

The DEMO function automatically demonstrates some of the TV functions.

- 1 Press the **▼/▲** buttons to choose **ON**
- 2 Press the **OK** button to complete the setting

*The DEMO function is set to ON, and the demonstration will start.*

#### To stop the demonstration:

Press one of the buttons on the remote control.

#### When the DEMO function is set to ON:

Each time the TV is turned on, the demonstration starts automatically. If you do not want that to happen, cancel the DEMO function:

- 1 Display the **DEMO** menu again
- 2 Press the **▼/▲** buttons to choose **OFF**
- 3 Press the **OK** button to cancel the **DEMO** function

# Other menus

## ■ Downloading data to a VCR

You can send the latest programme numbers (PR) data to a VCR with the T-V LINK function.

- You can only do this when a T-V LINK compatible VCR is connected to the EXT-2 terminal.
- This only works when the T-V LINK menu is being displayed.

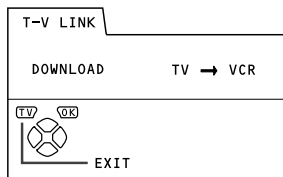

### 1 Turn on the VCR

### 2 Press the OK button

The data transmission begins.

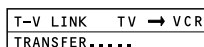

The T-V LINK menu disappears once the data transmission ends.

### When the T-V LINK menu changes over to another menu:

The TV has finished its menu. This new menu is operated from the VCR. See the VCR instruction manual for what to do next.

- If "FEATURE NOT AVAILABLE" appears at the T-V LINK menu, check the following three items. Then press the **OK** button to retry data transmission.
  - Has a T-V LINK compatible VCR been connected to the EXT-2 terminal?
  - Has the VCR power been turned on?
  - Does the SCART cable that connects the EXT-2 terminal to the T-V LINK compatible VCR have all its proper connections?

## ■ Using the DECODER (EXT-2) function

If you have a decoder connected to a T-V LINK compatible VCR, which in turn is connected to the EXT-2 terminal, use the DECODER (EXT-2) function to unscramble the scrambled TV channels.

### 1 Turn on the decoder power

### 2 Display the scrambled TV channel on the TV

Even if the decoder is working, a scrambled picture appears.

### 3 Press the OK button to display the MENU

The MENU (main menu) appears.

### 4 Press the ▼/▲ buttons to choose FEATURES. Then press the OK button

The FEATURES menu appears.

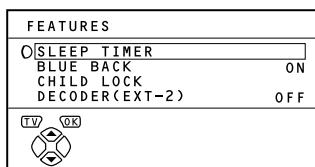

### 5 Press the ▼/▲ buttons to choose DECODER (EXT-2). Then press the ◀/▶ buttons to choose ON

An unscrambled picture appears.

### To cancel the DECODER (EXT-2) function:

Press the ◀/▶ buttons to choose OFF.

### 6 Press the OK button to complete the setting

The T-V LINK menu appears.

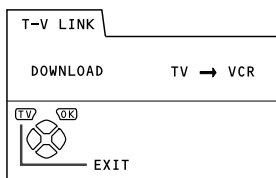

### 7 Follow "Downloading data to a VCR" on page 30 to transmit the programme number (PR) data to the VCR

### 8 If you have another TV channel you want to unscramble using a decoder, repeat steps 2 to 7.

- If the DECODER (EXT-2) function has been set to "ON" but the TV channel cannot be unscrambled, check the following:
  - Has the decoder been connected to the VCR properly according to the VCR and decoder instruction manuals?
  - Has the decoder power been turned on?
  - Can the TV channel be unscrambled with a decoder?
  - Do you need to change the VCR settings in order to connect the decoder? Confirm that the VCR is set properly by rechecking the VCR Instruction manual.

# Further preparation

## ■ Connecting external equipment

Connect the equipment to the TV, making the correct rear panel and front panel connections.

### Before connecting anything:

- Read the manuals that came with the equipment. Depending on the equipment, the connection method may be different from the diagram. Also, the equipment settings may need to change depending on the connection method.
- Turn off all the equipment including the TV.
- The "Specifications" on the back cover give the details of the EXT terminals. If you are connecting equipment not listed in the following connection diagram, see the table to choose the best EXT terminal.
- Connecting cables are not supplied.

- ① VCR (composite signal)
- ② VCR (composite signal/S-VIDEO signal)
- ③ T-V LINK compatible VCR (composite signal/S-VIDEO signal)
- ④ Decoder
- ⑤ DVD player (composite signal/S-VIDEO signal)
- ⑥ DVD player (composite signal/RGB signal)
- ⑦ TV game (composite signal/RGB signal)
- ⑧ TV game (composite signal/S-VIDEO signal)
- ⑨ Headphones
- ⑩ Camcorder (composite signal/S-VIDEO signal)
- ⑪ SCART cable
- ⑫ Audio cable
- ⑬ Video cable
- ⑭ S-VIDEO cable

### Behind the Cover

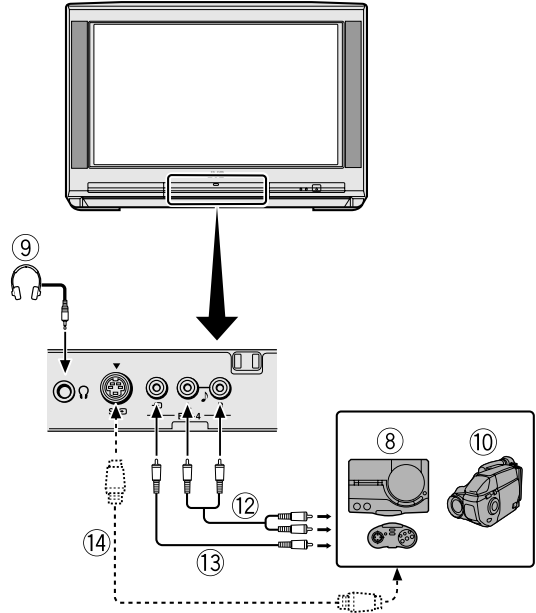

### Back of the TV

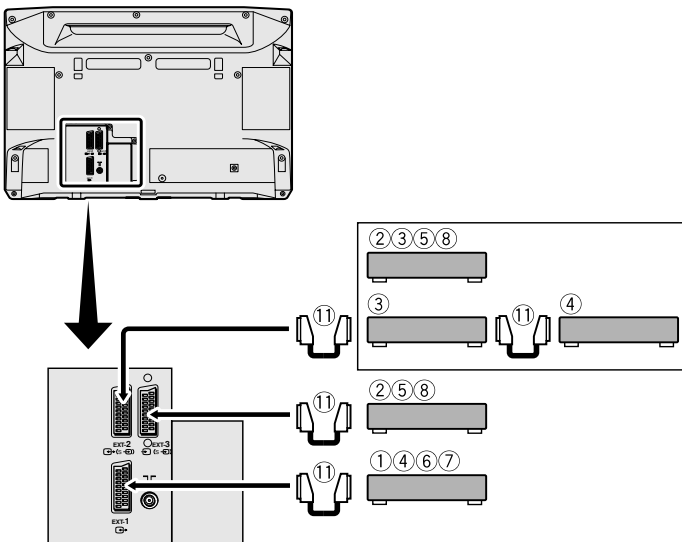

## **Equipment which can output the S-VIDEO signal (Y/C signal) such as an S-VHS VCR**

Connect the equipment to an EXT terminal (but not the EXT-1 terminal).

You can choose between an S-VIDEO signal (Y/C signal) and a regular video signal (composite signal). For details of how to operate the equipment, see "S  (S-VIDEO input)" on page 21.

## **T-V LINK compatible VCR**

Be sure to connect the T-V LINK compatible VCR to the EXT-2 terminal. If not, the T-V LINK function will not work properly.

- When connecting a T-V LINK compatible VCR to the EXT-2 terminal, be sure to connect the decoder to the VCR. If not, the T-V LINK function may not work properly. After you have stored TV channels in the programme numbers (PR) list, set the DECODER (EXT-2) function for the programme number (PR) to ON to unscramble a scrambled TV channel. For details, see "Using the DECODER (EXT-2) function" on page 30.

## **Connecting headphones**

Connect the headphones with a stereo mini-jack (3.5mm diameter) to the headphone jack at the TV front panel.

- When you connect the headphones, the TV speakers go off.

## **Video or sound signal output from the EXT-2 terminal**

You can change over the output of the video/sound signal from the EXT-2 terminal. This is useful when you want to dub the video/sound from another device onto the VCR connected to the EXT-2 terminal. For details on how to do this, see "DUBBING" on page 22.

## **TV output from the EXT-1 terminal**

The video/sound signal of a TV channel you are viewing is always output from the EXT-1 terminal.

- Changing over a programme number (PR) also changes over the TV output from the EXT-1 terminal.
- The video/sound signal from an EXT terminal cannot be output.
- Teletext programmes cannot be output.

# TV buttons and parts

## ■ Front panel

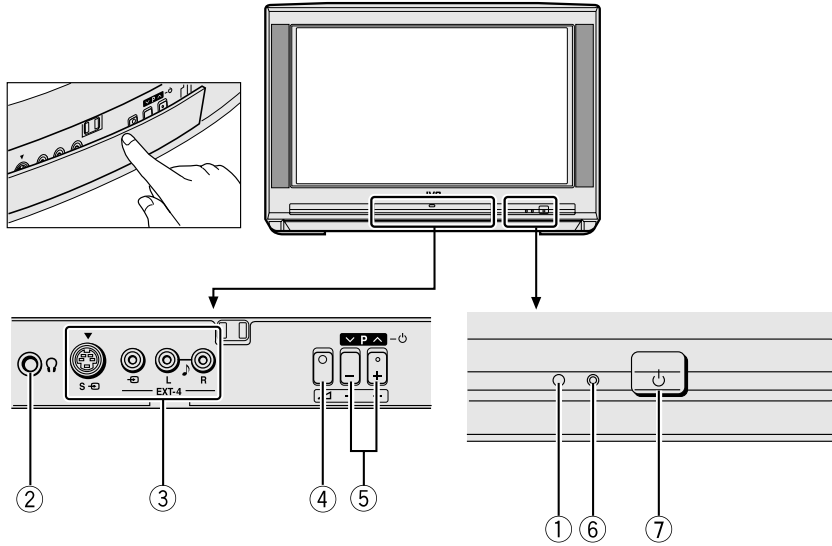

① Remote control sensor	
② Headphone jack (mini jack)	page 31
③ EXT-4 terminal	pages 21 and 31
④  (Volume) button	page 10

⑤ P $\nabla/\Delta$ buttons / $-/+$ buttons	page 10
⑥ Power lamp	pages 5 and 8
⑦ Main power button	pages 5 and 8

## ■ Rear Panel

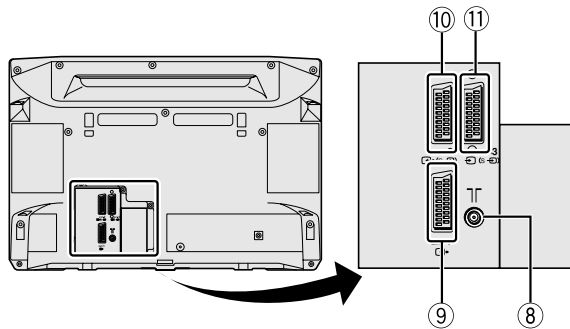

⑧ Aerial socket	page 4
⑨ EXT-1 terminal	pages 4, 21 and 31

⑩ EXT-2 terminal	pages 4, 7, 21 and 31
⑪ EXT-3 terminal	pages 21 and 31

# Troubleshooting

---

If a problem arises while you are using the TV, please read this troubleshooting guide carefully before you ask to have the TV repaired. You may be able to fix it easily by yourself. For example, if the mains plug is disconnected from the mains outlet, or the TV aerial has problems, you may think there is a problem with the TV itself.

## Important:

- This troubleshooting guide only covers problems whose causes are not easy to decide. If you have a question when you are operating a function, read the page(s) for that function carefully, not this troubleshooting guide.
- If you follow the advice in this troubleshooting guide without any success, unplug the mains plug and ask for your TV to be repaired. Do not attempt to repair the TV by yourself or to remove the rear cover of the TV.

## If you cannot turn on the TV

- Is the mains plug connected to the mains outlet?
- Is the power lamp lit? If not, press the main power button.

## No picture or no sound

- Have you chosen a TV channel with very poor reception? If so, the BLUE BACK function will be activated: the entire screen becomes blue, and the sound is muted. If you still want to view the TV channel, follow the description "BLUE BACK" on page 23 to try to change the BLUE BACK function setting to OFF.
- Have you connected headphones to the TV?  
Connecting headphones to the TV turns off the TV speakers.

## Poor picture

- If noise (snow) totally blocks out the picture, there may be a problem with the aerial or aerial cable. Check the following to try to solve the problem:
  - Have the TV and aerial been connected properly?
  - Has the aerial cable been damaged?
  - Is the aerial pointing in the right direction?
  - Is the aerial itself faulty?
- If the TV or aerial suffers interference from other equipment, stripes or noise may appear in the picture. Move any equipment such as an amplifier, personal computer, or a hair drier, that can cause interference away from your TV. Or try moving the TV. If the aerial suffers interference from a radio tower or high-voltage wire, please contact your local dealer.
- If the TV suffers interference from signals reflecting from mountains or buildings, double-pictures (ghosting) will occur. Try to change the aerial's direction or replace it with one with better directionality.
- Are your COLOUR SYSTEM settings correct? Follow the description "COLOUR SYSTEM" on page 18 to try a way to solve the trouble.
- Have the COLOUR and BRIGHT settings been adjusted properly? Follow the description "Picture adjustment" on page 17 to try to adjust them properly.
- Videotaping teletext is not recommended because it may not record correctly.
- When a white and bright still image (such as a white dress) is displayed on the screen, the white part may look as if it is coloured. This is unavoidable due to the nature of the picture tube itself, and not due to a TV failure. When the picture disappears from the screen, the unnatural colours will also disappear.
- When viewing images from commercially available video software products, or videos from videotapes which have been recorded improperly, the top of the image may be distorted. This is due to the condition of the video signal, and not because of malfunction.

## Poor sound

- Have you adjusted BASS or TREBLE properly? If not, follow the description "Sound adjustment" on page 20.
- When TV channel reception is poor, it can be hard to hear the stereo or bilingual sound. In this case, follow the description "STEREO / I•II" on page 20 to hear the sound more easily by changing it to a mono sound.

## If the TV does not respond to the remote control.

- Have the batteries of the remote control worn out? Follow the description "Putting batteries into the remote control" on page 4 and replace them with new batteries.
- Have you attempted to use the remote control from the sides or rear of the TV or from more than seven metres away from the TV? Use the remote control in the front of your TV or from less than seven metres away.
- When you are viewing a teletext programme, you cannot operate the menus. Press the **TV** button to return to the ordinary TV programme, and then try operating the menus.
- If the TV will not respond suddenly, press the main power button on the TV and turn off the main power. Press the main power button again to turn on the TV. If the TV returns to a normal state, it is not a failure.

## Other issues

- When the SLEEP TIMER function operates, the TV is automatically turned off. If the TV is turned off suddenly, try to press the  (standby) button to turn on the TV once again. If the TV goes back to normal, there is no problem.
- When a wide screen signal (WSS) is included in the broadcast signal or the signal from an external device, or when the TV is receiving a control signal from an external device, the ZOOM mode will change automatically. When you want to return to the previous ZOOM mode, press the **ZOOM** button to choose the ZOOM mode again.
- If you bring a magnetised device such as a speaker near to your TV, the picture may be warped or unnatural colors may appear at the corners of the screen. In this case, keep the device from your TV. If speakers cause this to happen, use magnetic-shielded speakers instead.
- It takes a short time from the time an operation such as changing channels is performed until an image is displayed. This is not a malfunction. This is the time it takes for the image to stabilize before it can be displayed.
- The TV may make a crackling sound due to a sudden change in temperature. The picture or sound may be normal. If you hear crackling sounds frequently while you are viewing the TV, there may be other causes. As a precaution, ask your service technician to inspect it.
- Touching the screen may cause you to feel a slight electric shock due to its static electricity. This is unavoidable due to the construction of the picture tube. It is not a problem with the TV. You can rest assured that this static discharge is not harmful.

# Specifications

Item	Model	AV28CT1EK* (UK model)	AV28CT1EI* (Ireland model)
Broadcasting systems		CCIR I	
Colour systems		PAL • The EXT terminals also support the NTSC 3.58/4.43 MHz system.	
Channels and frequencies		E21-E69	IR A-J, E2-E12, E21-E69, S1-S41, X, Y, Z, Z+1, Z+2, ITALY A-H, ITALY H+1, ITALY H+2
Sound-multiplex systems		NICAM (I) system	
Teletext systems		FLOF (Fastext), WST (World Standard Text)	
Power requirements		220 - 240 V AC, 50 Hz	
Power consumption		Maximum: 156 W, Average: 122 W, Standby: 0.8 W	
Picture tube size		Viewable area 66 cm (measured diagonally)	
Audio output		Rated Power output: 5 W + 5 W	
Speakers		(10 cm × 3 cm) oval × 2	
EXT-1 terminal		Euroconnector (21-pin, SCART) • Video input, Audio L/R inputs and RGB inputs are available. • TV broadcast outputs (Video and Audio L/R) are available.	
EXT-2 terminal		Euroconnector (21-pin, SCART) • Video input, S-VIDEO (Y/C) input and Audio L/R inputs are available. • Video and Audio L/R outputs are available. • T-V LINK functions are available.	
EXT-3 terminal		Euroconnector (21-pin, SCART) • Video input, S-VIDEO (Y/C) input and Audio L/R inputs are available.	
EXT-4 terminal		RCA connectors × 3 S-VIDEO connector × 1 • Video input, S-VIDEO (Y/C) input and Audio L/R inputs are available.	
Headphone jack		Stereo mini-jack (3.5 mm in diameter)	
Dimensions (W × H × D)		725 mm × 480 mm × 496 mm	
Weight		33.8 kg	
Accessories		Remote control unit × 1 (RM-C55 (Grey) or RM-C51 (Black) is supplied.) AAA/R03 dry cell battery × 2	

\* A basic model number. The actual model number may have characters added (such as "S" denoting silver) indicating the colour of the TV set.

**We may change the design and specifications without notice.**

Pictures displayed on the screen using this TV's ZOOM functions should not be shown for any commercial or demonstration purpose in public places (cafes, hotels, etc.) without the consent of the owners of copyright of the original picture sources, as this would be an infringement of copyright.